

OPEN BOOK



with you
361°

2017

Contatto

T. (+39) 02 8687 6001

F. (+39) 02 8687 6052

info-italia@grupo-gp.com

www.grupo-gp.com





INDICE GENERALE

Intro	5		
Elementi per lineare	11		
Tirastopper®	13		
Stopper	27		
Display e display stopper	39		
Porta prezzi per appenderia	55		
Strisce e indicatori per profili	63		
Fasce per cross merchandising	67		
Piedini e bandierine	71		
Espositori	79		
Bandelle promozionali	85		
Separatori verticali	89		
False masse	99		
Cornici promozionali	103		
Copri pallet	119		
Divisori	125		
Profili	133		
Soluzioni porta comunicazioni	141		
Tasche	143		
Porta messaggi da tavolo	153		
Telescopici e cornici	159		
Piede Americano	165		
Porta messaggi IFCO	171		
Base pato	175		
Porta messaggi per reparti	179		
Comunicazione banchi frigo e surgelati	185		
Separatori	187		
Evidenziatori di prezzo	197		
Soluzioni per esposizione	203		
Isole CUBEplex®	205		
Rivestimenti isola	225		
Flexidecor® Series	231		
Espositori di prodotto	239		
Espositori porta volantini	253		
Totem	261		
Leggii	275		
Coperture antitaccheggio	279		
Box porta messaggi	283		
Accessori per fissaggio	287		
Pinze e basette	289		
Ganci e accessori	297		
Elementi per fissaggio magnetico	307		
Nastri adesivi	311		
Comunicazione aerea	315		
Testate promozionali	317		
Complementi	331		
Kakemono	337		
FastUP	341		
Tasche formato XL	353		
Indicatori di corsia	357		
Piccoli accessori	361		
Profili per cartellonistica	367		
Comunicazione da terra, vetrate e pareti	373		
Comunicazione da terra	375		
OnCrystal	385		
Teli e tessuti	395		
Scritte 3D	401		
Decorazione a pareti	407		
Pennarelli e ricariche	413		
Pennarelli e ricariche	413		

Iconografia

Quantitativo minimo



Indica il quantitativo minimo di prodotto ordinabile. Il quantitativo varia a seconda del prodotto.

Confezionamento



Si riferisce al numero di unità incluse nella confezione, quantità che possono variare a seconda del prodotto.

Nota: Le misure contenute in questo catalogo sono soggette a modifiche o variazioni, a seconda delle materie prime.





“ Con te approfondiamo la strategia e gli obiettivi della tua azienda per dare loro forma concreta sul PDV con progetti, idee, e concetti di comunicazione elaborati in tempi record.

Con te progettiamo esperienze d'acquisto per i tuoi clienti.

Con te abbiamo pianificato più di 500 progetti.

Con te miglioriamo il tuo futuro, siamo il partner di fiducia che cura al massimo le esigenze quotidiane dei tuoi clienti.

Con te apriamo e chiudiamo la nostra catena *all in one*, dal disegno all'installazione passando per la produzione.

Con te comincia e finisce la nostra ragione di essere ”

Designing experiences with you





Nota legale: La presenza di brands terzi in questo catalogo, hanno valore puramente illustrativo e non hanno pertanto funzioni promozionali.



Laser
Lavorazione meccanizzata
Sagomatura automatica
Plotter da taglio

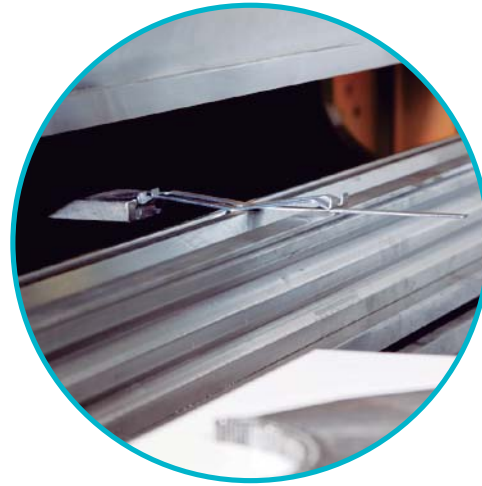

Piegatura a caldo e ad impatto
Piegatura metallica

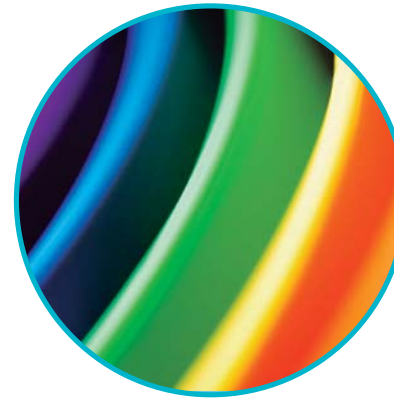

Stampa digitale latex e UV
Plotter da stampa
Serigrafia
Metalli



Stampi per accessori di iniezione.
Estrusione di profili.



Montaggio manuale
Saldatura

Sist. di Taglio

Sist. di Piegatura

Sist. di Stampa

SISTEMI DI PRODUZIONE

Sist. di modellazione Plastica

Sist. di Assemblaggio

GAMMA DI MATERIALI

Plastici

PVC
PET / PETG
PP cellulare
PP compatto



Spumosi

PVC espanso (Forex®)
Piuma

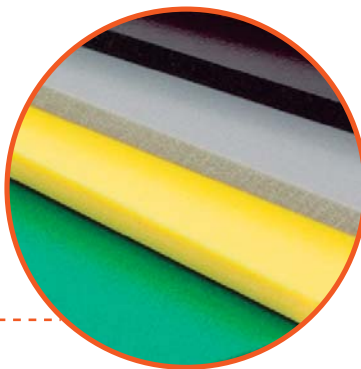

Polistirolo e
Acrilici

Sándwich Alluminio
Metacrilato
Metacrilato Resist
SAN UV
Policarbonato
Poliestirene

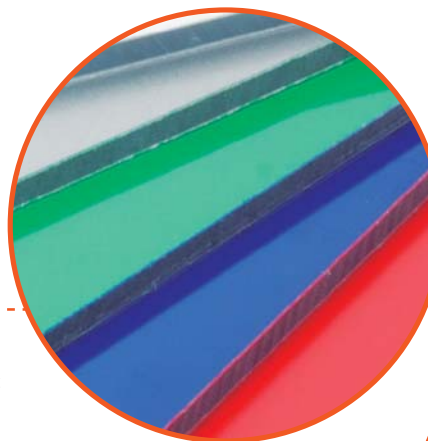

Alluminio
e metalli

Acciaio/Ferro



Tessuti

Flexidecor Series® (monocolore + stampa)
Teli e tessuti instore & outdoor
Vinili da taglio e stampa



Cartone

Legno

MDF
Conglomerati

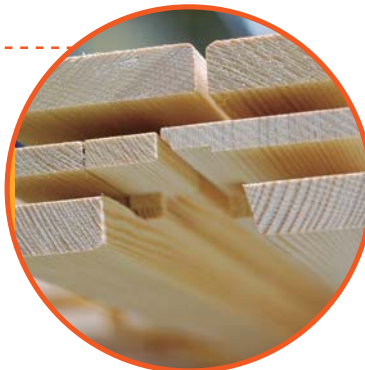

Cartone a Nido d'Ape (Re-board®)
Cartone Microcanale





Elegant coffee
3,35€



Elegant coffee
2,24€

Rich coffee
2,19€



Nuts coffee
2,78€

capsules

Whole Bean & Ground Coffee



HEAVY CREAM

HEAVY CREAM



2,56€



HIGH ROAST COFFEE

HIGH ROAST COFFEE



1,84€

3,7€

Whole Bean & Ground Coffee

Elementi per lineare



*Tirastopper®
Stopper
Display e display stopper
Porta prezzi per appenderia
Strisce e indicatori per profili
Fasce per cross merchandising
Piedini e bandierine
Espositori
Bandelle promozionali
Separatori verticali
False masse
Cornici promozionali
Copri pallet
Divisori
Profili*





Tirastopper®

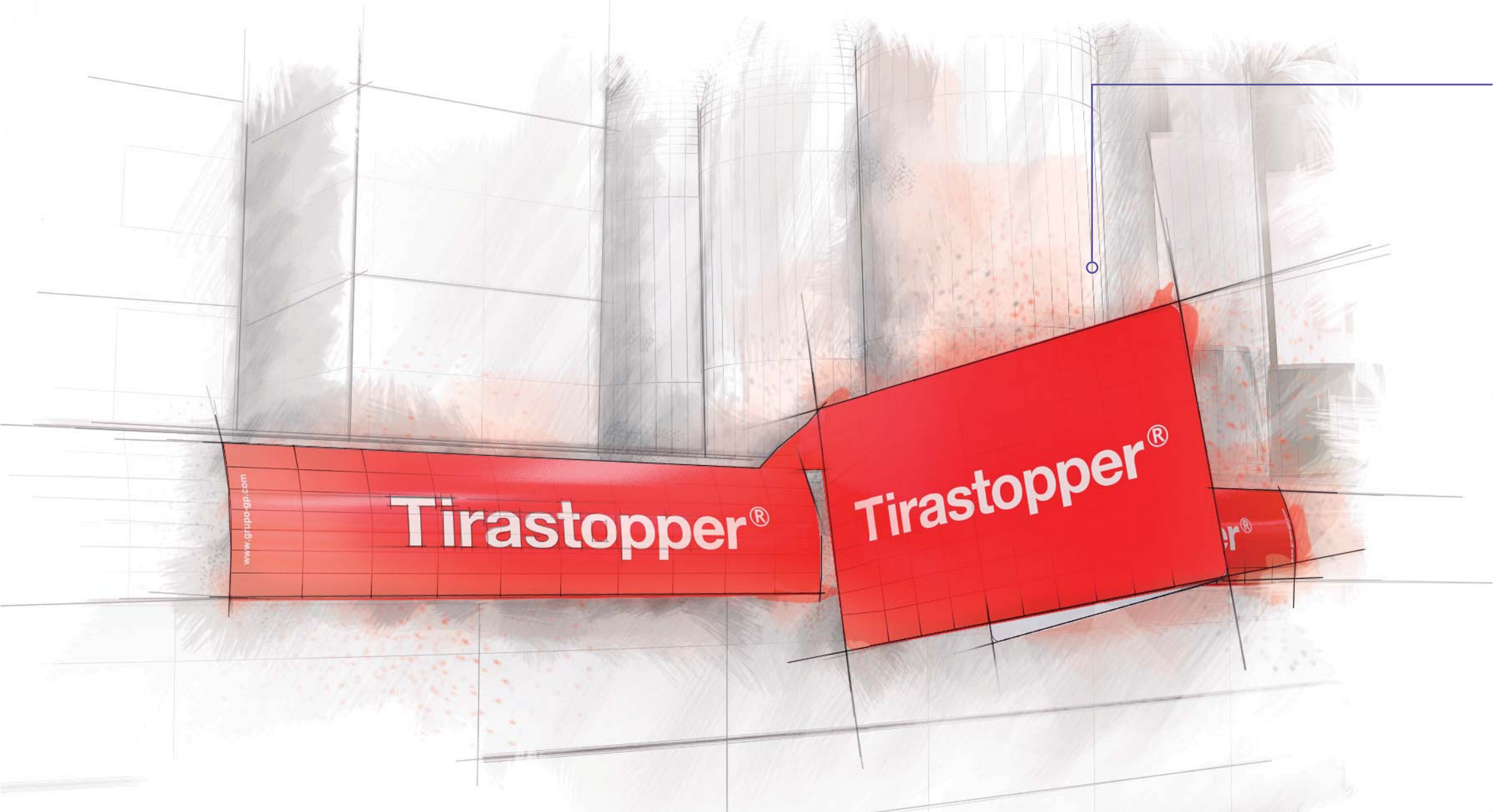

www.grupo-ap.com

Tirastopper®

Tirastopper®

Tirastopper®
PATENTED SYSTEM

“ I nostri clienti confermano che Tirastopper®
aiuta a farsi conoscere,
facing e impatto sul lineare ”

- Stiamo passando da un mercato basato sul consumo di massa a un mercato basato sulla qualità e diversità, in cui le famiglie di prodotti aumentano sempre di più. Per questo risulta sempre più importante e necessario avere visibilità sul lineare.

Tirastopper® è una soluzione di PPV ingegnosa la cui efficacia è stata testata e dimostrata direttamente sul punto vendita. Migliora l'immagine promozionale e l'impatto visivo del prodotto sul lineare e accresce il desiderio d'acquisto nel consumatore.



Applicazioni



Campagne lancio e stagionali o permanenti



Promozione di un marchio o di una famiglia di prodotti



Supporto visivo cross selling

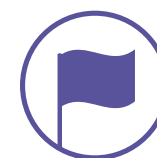

Tipicità regionali



Classificazione e segmentazione di prodotto



Distaccamento di categoria

Tirastopper®

PATENTED SYSTEM

Non è solo questione di forma ed estetica! La sua struttura offre soluzioni funzionali al punto di vendita.



3 in 1 Mette insieme le funzioni di striscia per profilo, pinza e stopper.



100% Personalizzabile

Qualsiasi progetto, in migliaia di forme.

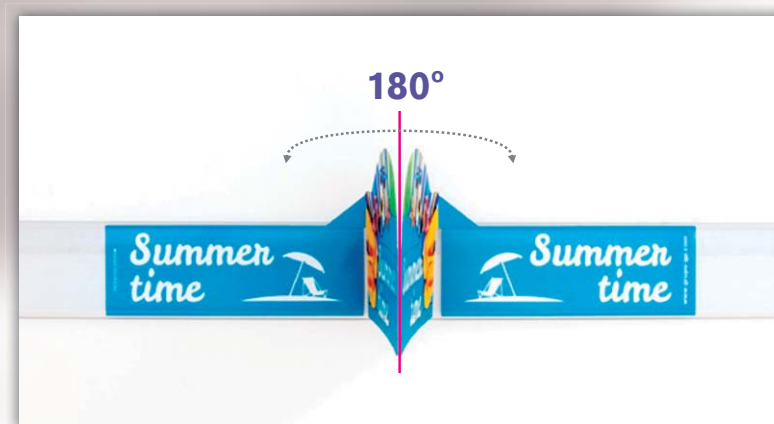

Angolo di visibilità a

180° Comunica tanto, frontalmente quanto lateralmente.



Adattabile a qualsiasi tipo di profilo porta prezzo standard.



Riduce i tempi di applicazione.



La sua struttura a "pezzo unico" garantisce l'installazione **veloce e durevole.**



-60% di tempo di installazione.

Per profili da **30 mm**

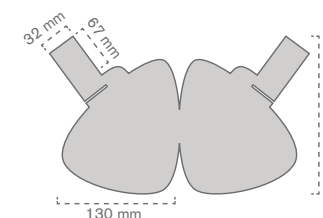
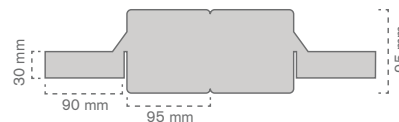

Ref.	Misure		Mat.	50	1000 u*
	Stopper	Striscia			
10010103700	78 x 67 mm	150 x 30 mm	PVC	50	1000 u*

Ref.	Misure		Mat.	50	1000 u*
	Stopper	Striscia			
10010103300	95 x 95 mm	90 x 30 mm	PVC	50	1000 u*

Ref.	Misure		Mat.	50	1000 u*
	Stopper	Striscia			
10010106800	130 x 160 mm	67 x 32 mm	PVC	50	1000 u*

Per profili da **40 mm**

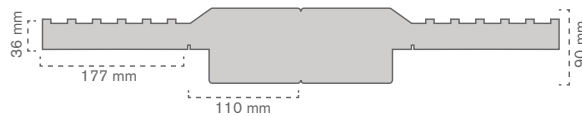

Ref.	Misure		Mat.	50	1000 u*
	Stopper	Striscia			
10010107300	110 x 90 mm	177 x 36 mm	PVC	50	1000 u*

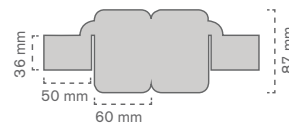

Ref.	Misure		Mat.	50	1000 u*
	Stopper	Striscia			
10010105200	60 x 87 mm	50 x 36 mm	PVC	50	1000 u*

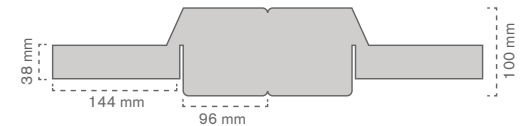

Ref.	Misure		Mat.	50	1000 u*
	Stopper	Striscia			
10010101700	96 x 100 mm	144 x 38 mm	PVC	50	1000 u*

*Ordine minimo per stampa in serigrafia. Per stampa digitale l'ordine minimo è di 250 unt.

Per profili da 40 mm

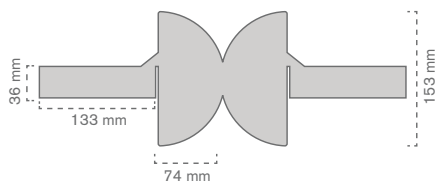

Ref.	Misure		Mat.	50	1000 u*
	Stopper	Striscia			
10010107600	74 x 153 mm	133 x 36 mm	PVC	50	1000 u*

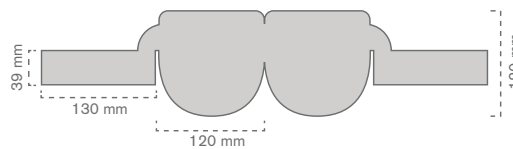

Ref.	Misure		Mat.	50	1000 u*
	Stopper	Striscia			
10010106000	120 x 120 mm	130 x 39 mm	PVC	50	1000 u*

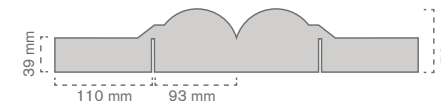

Ref.	Misure		Mat.	50	1000 u*
	Stopper	Striscia			
10010108000	93 x 72 mm	110 x 39 mm	PVC	50	1000 u*

Per profili da **40 mm**

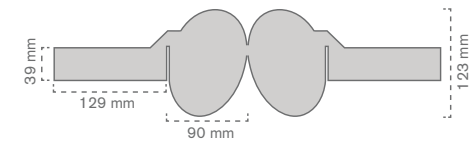
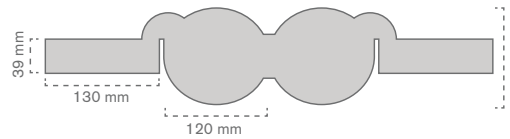
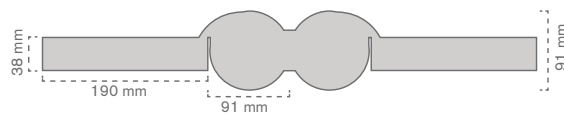

Ref.	Misure		Mat.	50	1000 u*
	Stopper	Striscia			
10010101000	91 x 91 mm	190 x 38 mm	PVC	50	1000 u*

Ref.	Misure		Mat.	50	1000 u*
	Stopper	Striscia			
10010105000	120 x 110 mm	130 x 39 mm	PVC	50	1000 u*

Ref.	Misure		Mat.	50	1000 u*
	Stopper	Striscia			
10010101200	90 x 123 mm	129 x 39 mm	PVC	50	1000 u*

*Ordine minimo per stampa in serigrafia. Per stampa digitale l'ordine minimo è di 250 unt.

Per profili da 40 mm

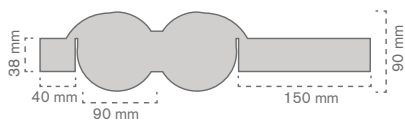

Ref.	Misure		Mat.	🛍️	📄
	Stopper	Striscia			
10010101400	90 x 90 mm	40/150 x 38 mm	PVC	50	1000 u*

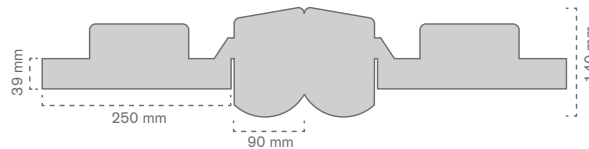

Ref.	Misure		Mat.	🛍️	📄
	Stopper	Striscia			
10010109000	90 x 140 mm	250 x 39 mm	PVC	50	1000 u*

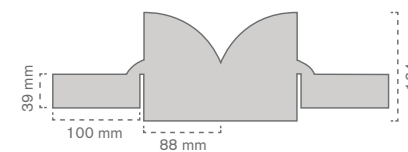

Ref.	Misure		Mat.	🛍️	📄
	Stopper	Striscia			
10010105700	88 x 124 mm	100 x 39 mm	PVC	50	1000 u*

Per profili da **50 mm**

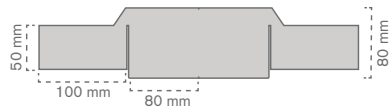

Ref.	Misure		Mat.	50	1000 u*
	Stopper	Striscia			
10010102500	80 x 80 mm	100 x 50 mm	PVC	50	1000 u*

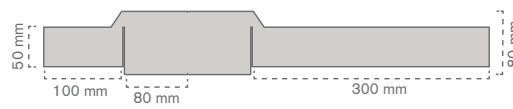

Ref.	Misure		Mat.	50	1000 u*
	Stopper	Striscia			
10010102600	80 x 80 mm	100/300 x 50 mm	PVC	50	1000 u*

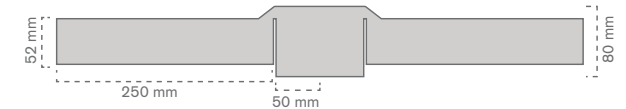

Ref.	Misure		Mat.	50	1000 u*
	Stopper	Striscia			
10010102300	50 x 80 mm	250 x 52 mm	PVC	50	1000 u*

*Ordine minimo per stampa in serigrafia. Per stampa digitale l'ordine minimo è di 250 unt.



Minute Maid

“Con un solo articolo puoi comunicare frontalmente e lateralmente. Inoltre aiuta a delimitare lo spazio del tuo marchio o prodotto”.



Nordic Mist



Central Lechera Asturiana



Seagram's



Danone



Cornetto



Nestea



Fanta



Mercadona



Plasmon

“È famoso, diverso e ottiene un maggior impatto sul consumatore”.

Dpto. Trademarketing Florette





Stopper

Per pinza

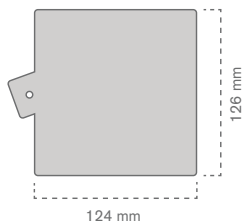

Ref.	Misure	Mat.		
10010200100	124 x 126 mm	PVC	25	1000 u*

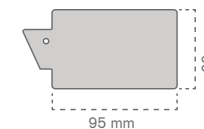

Ref.	Misure	Mat.		
10010200300	95 x 60 mm	PVC	25	1000 u*

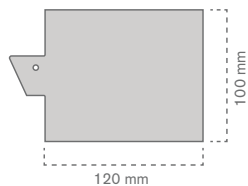

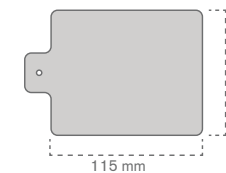

Ref.	Misure	Mat.		
10010200200	120 x 100 mm	PVC	25	1000 u*



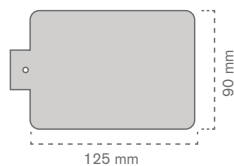

Ref.	Misure	Mat.		
10010200400	115 x 95 mm	PVC	25	1000 u*

Per pinza



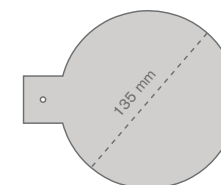

Ref.	Misure	Mat.		
10010200500	125 x 90 mm	PVC	25	1000 u*



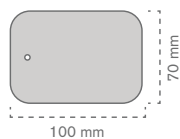

Ref.	Misure	Mat.		
10010200700	Ø135 mm	PVC	25	1000 u*

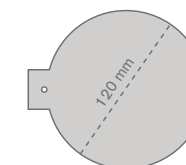

Ref.	Misure	Mat.		
10010200600	100 x 70 mm	PVC	25	1000 u*



Ref.	Misure	Mat.		
10010200800	Ø120 mm	PVC	25	1000 u*

*Ordine minimo per stampa in serigrafia. Per stampa digitale l'ordine minimo è di 250 unt.

Per pinza

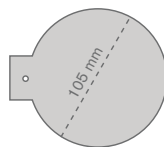

Ref.	Misure	Mat.		
10010200900	Ø105 mm	PVC	25	1000 u*

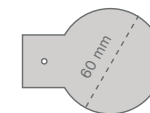

Ref.	Misure	Mat.		
10010201100	Ø60 mm	PVC	25	1000 u*

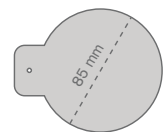

Ref.	Misure	Mat.		
10010201000	Ø85 mm	PVC	25	1000 u*

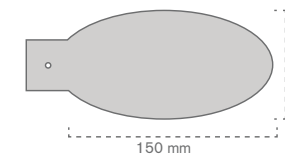

Ref.	Misure	Mat.		
10010201200	150 x 75 mm	PVC	25	1000 u*

Per etichetta elettronica

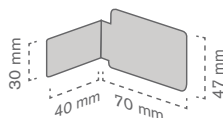

Ref.	Misure		Mat.	🛒	📄
	Striscia	Stopper			
10010201300	40 x 30 mm	70 x 47 mm	PVC	25	1000 u*

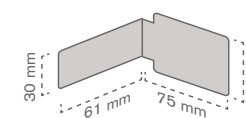

Ref.	Misure		Mat.	🛒	📄
	Striscia	Stopper			
10010201500	61 x 30 mm	75 x 47 mm	PVC	25	1000 u*

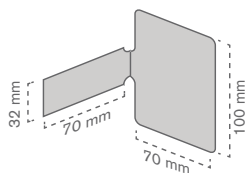

Ref.	Misure		Mat.	🛒	📄
	Striscia	Stopper			
10010201400	70 x 32 mm	70 x 100 mm	PVC	25	1000 u*

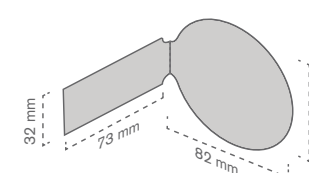

Ref.	Misure		Mat.	🛒	📄
	Striscia	Stopper			
10010201600	73 x 32 mm	82 x 80 mm	PVC	25	1000 u*

*Ordine minimo per stampa in serigrafia. Per stampa digitale l'ordine minimo è di 250 unt.

Per profili

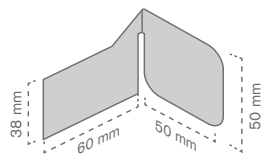

Ref.	Misure		Mat.	🛒	📅
	Striscia	Stopper			
10010201700	60 x 38	50 x 50 mm	PVC	25	1000 u*

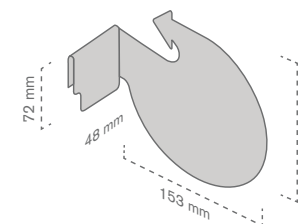

Ref.	Misure		Mat.	🛒	📅
	Striscia	Stopper			
10010201900	48 x 72 mm	153 x 159 mm	PVC	25	1000 u*

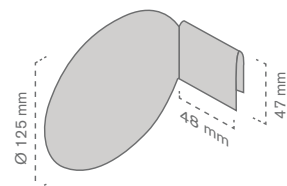

Ref.	Misure		Mat.	🛒	📅
	Striscia	Stopper			
10010201800	48 x 47	Ø125 mm	PVC	25	1000 u*

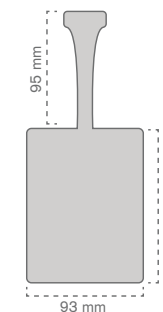

Ref.	Misure		Mat.	🛒	📅
	Striscia	Stopper			
10010202000	95 mm	93 x 122 mm	PVC	25	1000 u*

Per **profili**

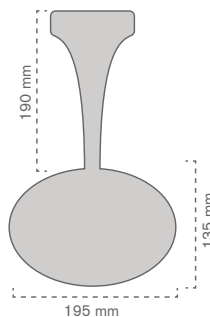

Ref.	Misure		Mat.	🛒	📄
	Striscia	Stopper			
10010202100	190 mm	195 x 135 mm	PVC	25	1000 u*

Con adesivo

Per porta prezzi per **appenderia** da 120 x 40 mm

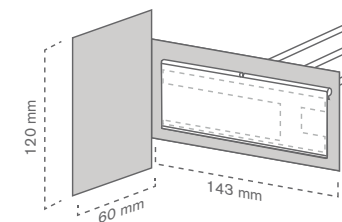

Ref.	Misure	Mat.	🛒	📄

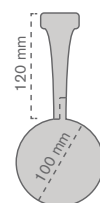

Ref.	Misure		Mat.	🛒	📄
	Striscia	Stopper			
10010202200	120 mm	Ø100 mm	PVC	25	1000 u*

Con Adesivo

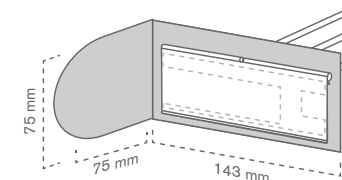



Ref.	Misure	Mat.	🛒	📄

*Ordine minimo per stampa in serigrafia. Per stampa digitale l'ordine minimo è di 250 unt.

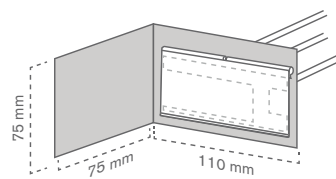

Per porta prezzi per **appenderia** da 90 x 40 mm

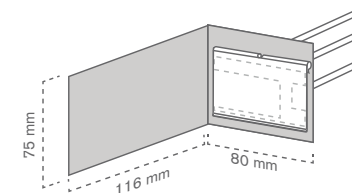

Ref.	Misure	Mat.		
10010202300	75 x 75 mm	PVC	25	1000 u*

Per porta prezzi per **appenderia** da 65 x 40 mm



Ref.	Misure	Mat.		
10010202400	116 x 75 mm	PVC	25	1000 u*

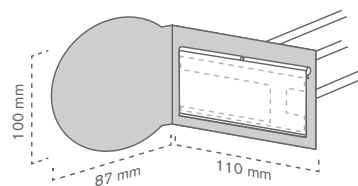

Ref.	Misure	Mat.		
10010202600	87 x 100 mm	PVC	25	1000 u*

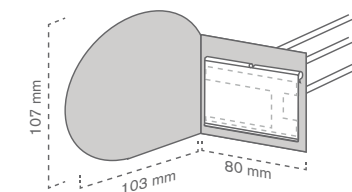

Ref.	Misure	Mat.		
10010202700	103 x 107 mm	PVC	25	1000 u*

Per porta prezzi per **appenderia** da 60 x 40 mm

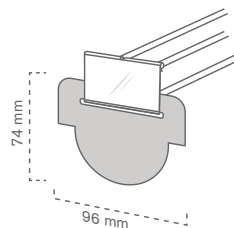

Ref.	Misure	Mat.		
10010202900	96 x 74 mm	PVC	25	1000 u*

Per **striscia adesiva**

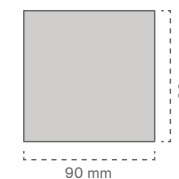

Ref.	Misure	Mat.		
10010203100	90 x 90 mm	PVC	25	1000 u*

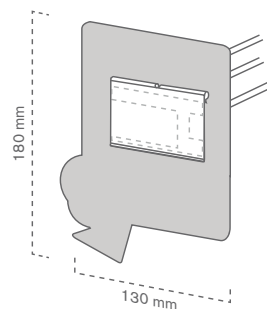

Ref.	Misure	Mat.		
10010203000	130 x 180 mm	PVC	25	1000 u*

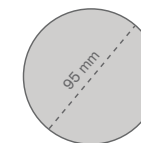

Ref.	Misure	Mat.		
10010203200	Ø95 mm	PVC	25	1000 u*

*Ordine minimo per stampa in serigrafia. Per stampa digitale l'ordine minimo è di 250 unt.

Pinza per stopper



Ref.	Misure	Mat.		
10050101200	35 x 51 mm	PP Semitrasparente	100	100 u

Pinza stopper perforata.
Efficace per fissare stopper e separatori ai profili di linea-re.

Stick e striscia flessibile con adesivo

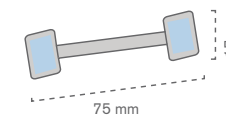
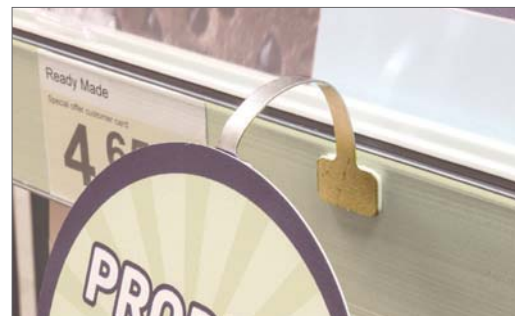

Ref.	Misure	Mat.		
10010203500	75 x 17 mm	Metallo	100	100 u

Stick metallico adesivo.
Stick metallico con adesivo spugnoso. Ideale per il fissaggio di stopper al lineare.

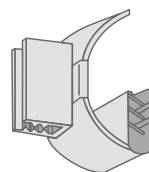
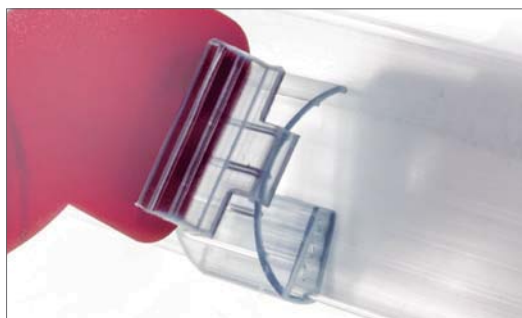

Ref.	Misure	Mat.		
10050101300	45 x 51 mm	PVC TTE	100	100 u

Pinza stopper regolabile.
La pinza regolabile permette di posizionare lo stopper a differenti altezze e angolazioni.

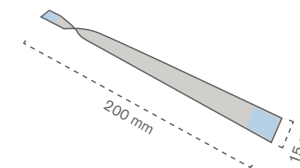

Ref.	Misure	Mat.		
10010203600	200 x 15 mm	PVC BCO	100	100 u

Striscia flessibile Twister.
Modello con adesivo spugnoso. Particolarmente indicato per cartellini promozionali. Stampa bifacciale.

Striscia flessibile con adesivo

Ref.	Misure	Mat.		
10010203800	200 x 15 mm	PVC TTE	100	100 u
10010203900	150 x 10 mm	PVC TTE	100	100 u

Striscia flessibile.

Striscia flessibile con adesivo cellulosica. Indicata per posizionare cartellini promozionali leggeri.





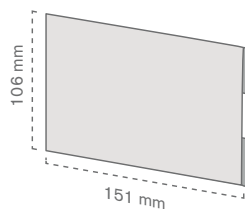

Display e display stopper

Display frontale **standard**

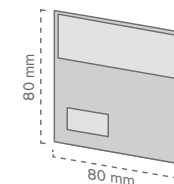
Ref.	Misure	Mat.		
10010300100	150 x 106 mm	PVC TTE	50	250 u



Ref.	Misure	Mat.		
10010300300	80 x 80 mm	PVC TTE	50	1000 u*

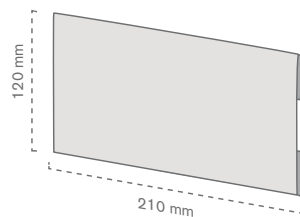

Ref.	Misure	Mat.		
10010300200	210 x 120 mm	PVC TTE	50	250 u

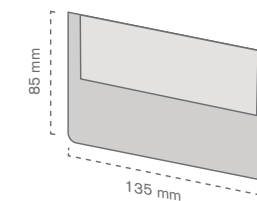

Ref.	Misure	Mat.		
10010300400	135 x 85 mm	PVC TTE	50	1000 u*

Display frontale con taglio in fustella

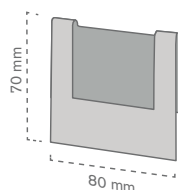

Ref.	Misure		Mat.	🛒	📄
	Display	Etiqueta			
10010300500	80 x 70 mm	60 x 40 mm	PVC BCO	50	1000 u*

Display frontale con profilo abbattibile

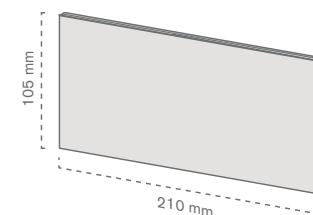

Ref.	Misure	Mat.	🛒	📄

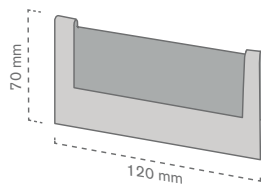
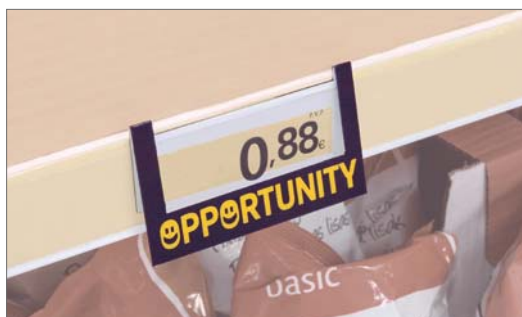

Ref.	Misure		Mat.	🛒	📄
	Display	Etiqueta			
10010300600	120 x 70 mm	100 x 40 mm	PVC BCO	50	1000 u*

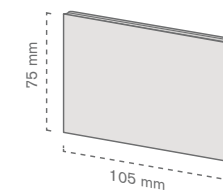

NEW

Ref.	Misure	Mat.	🛒	📄

*Ordine minimo per stampa in serigrafia. Per stampa digitale l'ordine minimo è di 250 unt.

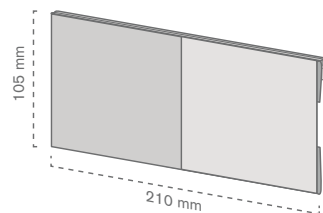
Display frontale con **profilo abbattibile**

Ref.	Misure	Mat.		
10010300900	210 x 105 mm	PVC TTE	25	1000 u*

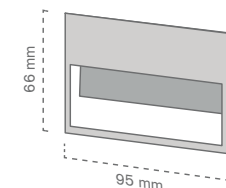
Display frontale per **etichetta elettronica**

Ref.	Misure	Mat.		
10010301100	95 x 66 mm	PVC TTE	25	1000 u*

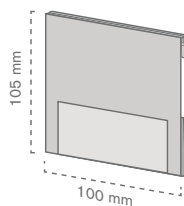

Ref.	Misure	Mat.		
10010301000	100 x 105 mm	PVC TTE	25	1000 u*

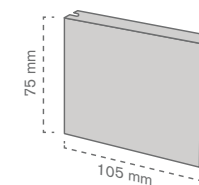

Ref.	Misure	Mat.		
10010301200	105 x 75 mm	PVC TTE	25	250 u

Display frontale per **eticheta elettronica**

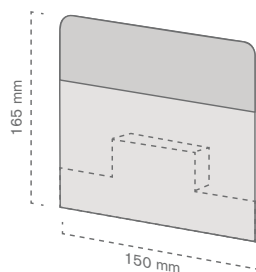

Ref.	Misure		Mat.	🛒	📄
	Display	Eticheta			
10010301300	150 x 165 mm	70 x 33 mm	PVC TTE	25	1000 u*

Display frontale **speciale**

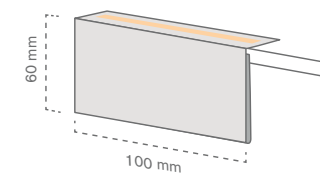

Ref.	Misure	Mat.	🛒	📄

Modello provvisto di adesivo cellulosa.

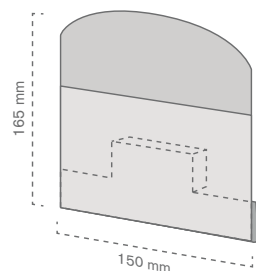

Ref.	Misure		Mat.	🛒	📄
	Display	Eticheta			
10010301400	150 x 165 mm	70 x 33 mm	PVC TTE	25	1000 u*

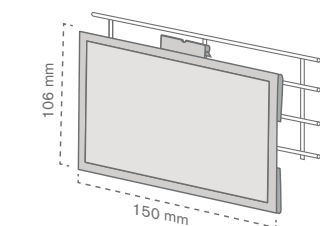

Ref.	Misure	Mat.	🛒	📄

*Ordine minimo per stampa in serigrafia. Per stampa digitale l'ordine minimo è di 250 unt. Finestra trasparente personalizzabile in tutti i modelli di questo tipo.

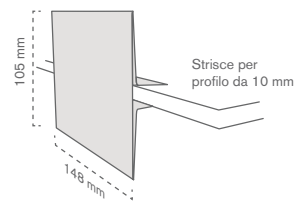
Display frontale **speciale**

Ref.	Misure	Mat.		
10010301700	148 x 105 mm	PETG	25	250 u

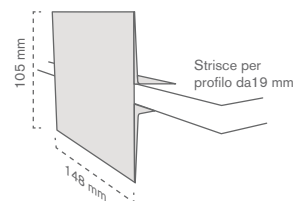

Ref.	Misure	Mat.		
10010301800	148 x 105 mm	PETG	25	250 u

Display stopper **standard**

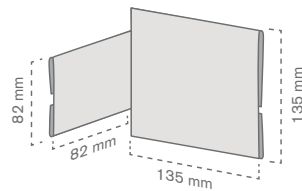

Ref.	Misure		Mat.	🛒	📄
	Display	Stopper			
10010301900	82 x 82 mm	135 x 135 mm	PVC TTE	50	250 u

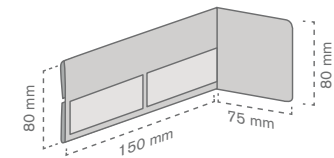

Ref.	Misure		Mat.	🛒	📄
	Display	Stopper			
10010302100	150 x 80 mm	75 x 80 mm	PVC TTE	50	1000 u*

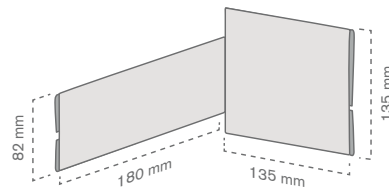

Ref.	Misure		Mat.	🛒	📄
	Display	Stopper			
10010302000	180 x 82 mm	135 x 135 mm	PVC TTE	50	250 u

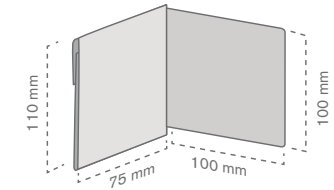

Ref.	Misure		Mat.	🛒	📄
	Display	Stopper			
10010302200	75 x 110 mm	100 x 100 mm	PVC TTE	50	1000 u*

*Ordine minimo per stampa in serigrafia. Per stampa digitale l'ordine minimo è di 250 unt.
Finestra trasparente personalizzabile in tutti i modelli di questo tipo.

Display stopper **standard**

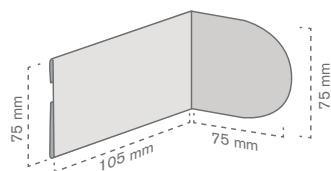

Ref.	Misure		Mat.	🛒	📄
	Display	Stopper			
10010302300	105 x 75 mm	75 x 75 mm	PVC TTE	50	1000 u*

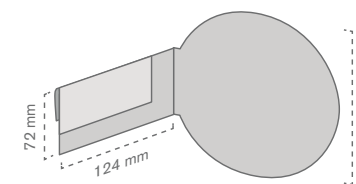

Ref.	Misure		Mat.	🛒	📄
	Display	Stopper			
10010302500	124 x 72 mm	Ø180 mm	PVC TTE	50	1000 u*

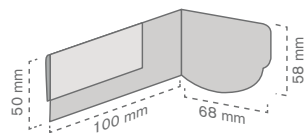

Ref.	Misure		Mat.	🛒	📄
	Display	Stopper			
10010302400	100 x 50 mm	68 x 58 mm	PVC TTE	50	1000 u*

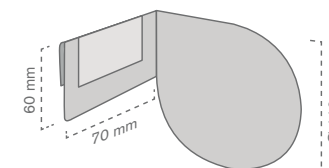

Ref.	Misure		Mat.	🛒	📄
	Display	Stopper			
10010302600	70 x 60 mm	Ø110 mm	PVC TTE	50	1000 u*

Display stopper con taglio in fustella

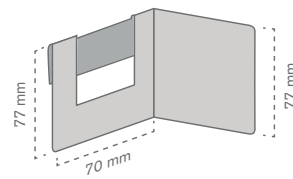
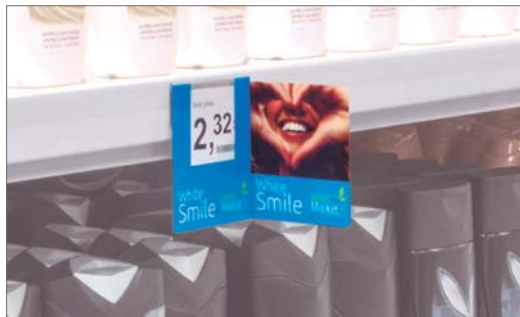

Ref.	Misure		Mat.	🛒	📄
	Eticheta	Stopper			
10010302700	40 x 44 mm	70 x 77 mm	PVC BCO	50	1000 u*

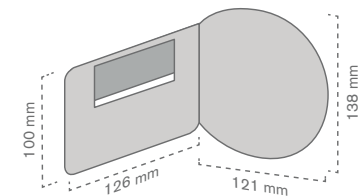

Ref.	Misure		Mat.	🛒	📄
	Eticheta	Stopper			
10010302900	65 x 35 mm	121 x 138 mm	PVC BCO	50	1000 u*

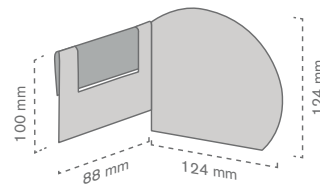

Ref.	Misure		Mat.	🛒	📄
	Eticheta	Stopper			
10010302800	65 x 42 mm	124 x 124 mm	PVC BCO	50	1000 u*

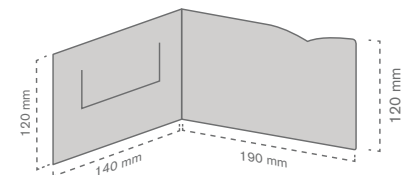

Ref.	Misure		Mat.	🛒	📄
	Eticheta	Stopper			
10010303000	80 x 40 mm	190 x 120 mm	PVC BCO	50	1000 u*

*Ordine minimo per stampa in serigrafia. Per stampa digitale l'ordine minimo è di 250 unt.

Display stopper con **profilo abbattibile**

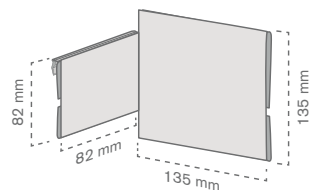

Ref.	Misure		Mat.	🛒	📄
	Display	Stopper			
10010303200	82 x 82 mm	135 x 135 mm	PVC TTE	25	250 u

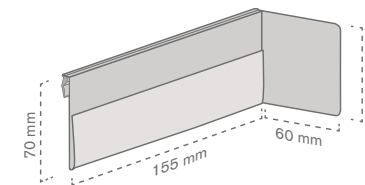

Ref.	Misure		Mat.	🛒	📄
	Display	Stopper			
10010303100	155 x 70 mm	60 x 70 mm	PVC TTE	25	1000 u*

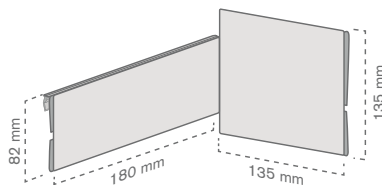

Ref.	Misure		Mat.	🛒	📄
	Display	Stopper			
10010303300	180 x 82 mm	135 x 135 mm	PVC TTE	25	250 u

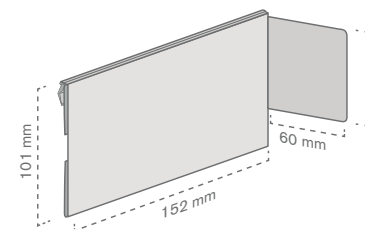

Ref.	Misure		Mat.	🛒	📄
	Display	Stopper			
10010303400	152 x 101 mm	60 x 70 mm	PVC TTE	25	1000 u*

Display stopper con profilo abbattibile

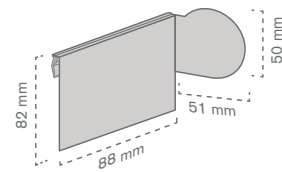

Ref.	Misure		Mat.	🛒	📄
	Display	Stopper			
10010303500	88 x 82 mm	51 x 50 mm	PVC TTE	25	1000 u*

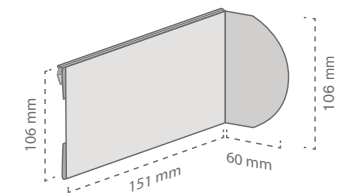

Ref.	Misure		Mat.	🛒	📄
	Display	Stopper			
10010303700	151 x 106 mm	60 x 106 mm	PVC TTE	25	1000 u*

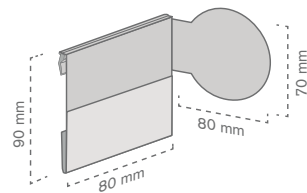

Ref.	Misure		Mat.	🛒	📄
	Display	Stopper			
10010303600	80 x 90 mm	80 x 70 mm	PVC TTE	25	1000 u*

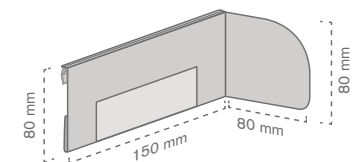

Ref.	Misure		Mat.	🛒	📄
	Display	Stopper			
10010303800	150 x 80 mm	80 x 80 mm	PVC TTE	25	1000 u*

*Ordine minimo per stampa in serigrafia. Per stampa digitale l'ordine minimo è di 250 unt.
Finestra trasparente personalizzabile in tutti i modelli di questo tipo.

Display stopper con **profilo abbattibile**

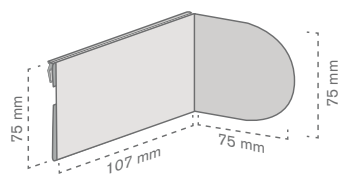

Ref.	Misure		Mat.	🛒	📄
	Display	Stopper			
10010303900	107 x 75 mm	75 x 75 mm	PVC TTE	25	1000 u*

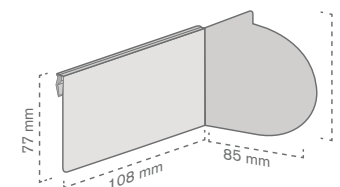

Ref.	Misure		Mat.	🛒	📄
	Display	Stopper			
10010304100	108 x 77 mm	85 x 93 mm	PVC TTE	25	1000 u*

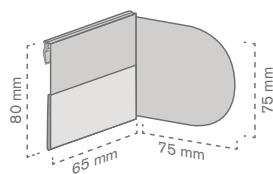

Ref.	Misure		Mat.	🛒	📄
	Display	Stopper			
10010304000	65 x 80 mm	75 x 75 mm	PVC TTE	25	1000 u*

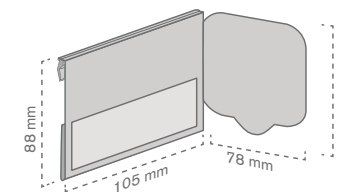

Ref.	Misure		Mat.	🛒	📄
	Display	Stopper			
10010304200	105 x 88 mm	78 x 88 mm	PVC TTE	25	1000 u*

Display stopper per profilo con etichetta elettronica

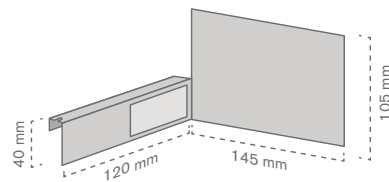

Ref.	Misure		Mat.	🛒	📄
	Eticheta	Stopper			
10010304300	110 x 33 mm	145 x 105 mm	PVC TTE	25	1000 u*

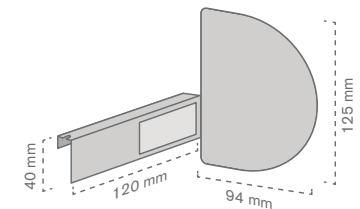

Ref.	Misure		Mat.	🛒	📄
	Eticheta	Stopper			
10010304500	110 x 33 mm	94 x 125 mm	PVC TTE	25	1000 u*

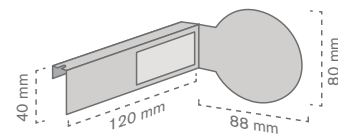

Ref.	Misure		Mat.	🛒	📄
	Eticheta	Stopper			
10010304400	110 x 33 mm	88 x 80 mm	PVC TTE	25	1000 u*

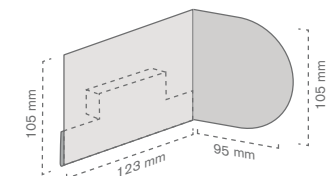

Ref.	Misure		Mat.	🛒	📄
	Eticheta	Stopper			
10010304600	70 x 33 mm	95 x 105 mm	PVC TTE	25	1000 u*

*Ordine minimo per stampa in serigrafia. Per stampa digitale l'ordine minimo è di 250 unt. Finestra trasparente personalizzabile in tutti i modelli di questo tipo.

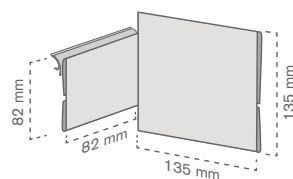
Display stopper con **profilo SlimLine**

Ref.	Misure		Mat.	🛒	📄
	Display	Stopper			
10010304700	82 x 82 mm	135 x 135 mm	PVC TTE	25	250 u

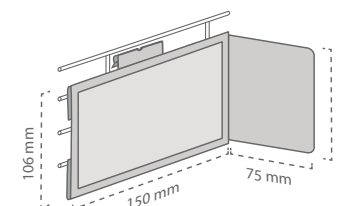
Display stopper **speciale**

Ref.	Misure		Mat.	🛒	📄
	Display	Stopper			
10010304900	150 x 106 mm	75 x 98 mm	PVC TTE	50	1000 u*

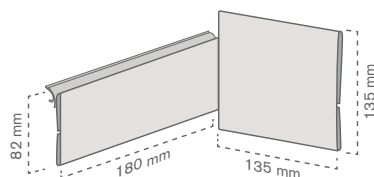

Ref.	Misure		Mat.	🛒	📄
	Display	Stopper			
10010304800	180 x 82 mm	135 x 135 mm	PVC TTE	25	250 u

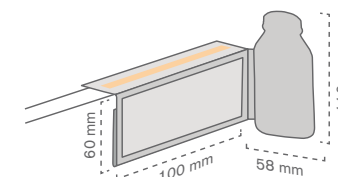

Ref.	Misure		Mat.	🛒	📄
	Display	Stopper			
10010305000	100 x 60 mm	58 x 110 mm	PVC TTE	50	1000 u*

Modello provvisto di adesivo cellulosa.





Porta prezzi per appenderia

Porta prezzi **orizzontale standard**

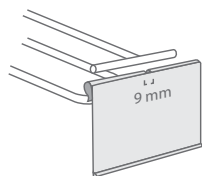

Ref.	Misure	Mat.	Icone	
			🛍️	📄
10010400100	105 x 39 mm	PVC TTE	500	500 u
10010400101	105 x 39 mm	PVC BCO	500	500 u
10010400200	75 x 39 mm	PVC TTE	750	750 u
10010402400	75 x 39 mm	PVC BCO	750	750 u
10010400300	65 x 39 mm	PVC TTE	1000	1000 u
10010400301	65 x 39 mm	PVC BCO	1000	1000 u

A richiesta disponibile in altri colori.

Porta prezzi **verticale standard**

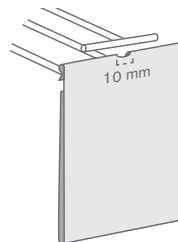

NEW

Ref.	Misure	Mat.	Icone	
			🛍️	📄
10010403100	A3 Verticale	PVC	50	50 u
10010403000	A4 Verticale	PVC	50	50 u
10010400400	A5 (150 x 210 mm)	PVC	50	50 u
10010400500	A6 (105 x 148 mm)	PVC	50	50 u
12000002900	A7 (74 x 105 mm)	PVC	50	50 u

Porta prezzi **personalizzato linguetta frontale**

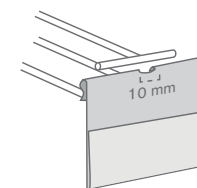

Ref.	Misure		Mat.	Icone	
	Generale	Linguetta		🛍️	📄
10010400600	70 x 70 mm	70 x 50 mm	PVC	100	1000 u*
10010400700	65 x 65 mm	65 x 40 mm	PVC	100	1000 u*

Porta prezzi **personalizzato** linguetta **posteriore**

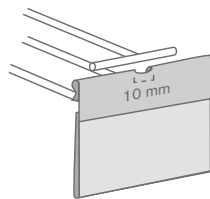

Ref.	Misure		Mat.	🛒	📄
	Generale	Linguetta			
10010400800	70 x 70 mm	70 x 50 mm	PVC	100	1000 u*
10010400900	65 x 65 mm	65 x 45 mm	PVC	100	1000 u*

Porta prezzi **personalizzato 65 mm**

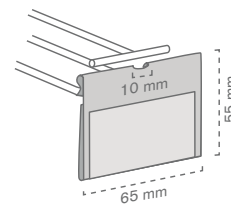

Ref.	Misure		Mat.	🛒	📄
	Generale	Linguetta			
10010401000	65 x 55 mm	65 x 30 mm	PVC	100	1000 u*

Porta prezzi con **stopper passo 10**

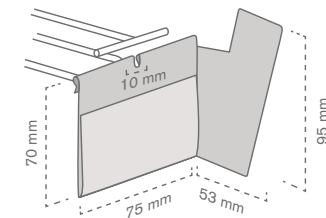

Ref.	Misure		Mat.	🛒	📄
	Linguetta	Stopper			
10010401100	75 x 40 mm	53 x 95 mm	PVC	50	1000 u*

*Ordine minimo per stampa in serigrafia. Per stampa digitale l'ordine minimo è di 250 unt.

58 Porta prezzi per appenderia

Porta prezzi con **stopper passo 10**

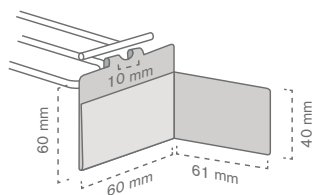

Ref.	Misure		Mat.	50	1000 u*
	Linguetta	Stopper			
10010401400	60 x 40 mm	61 x 40 mm	PVC	50	1000 u*

Porta prezzi con **stopper passo 6**

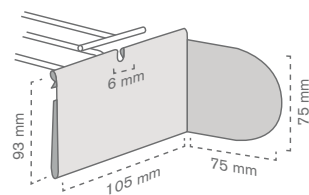

Ref.	Misure		Mat.	50	1000 u*
	Linguetta	Stopper			
10010401200	105 x 50 mm	75 x 75 mm	PVC	50	1000 u*

Porta prezzi con **stopper passo 21**

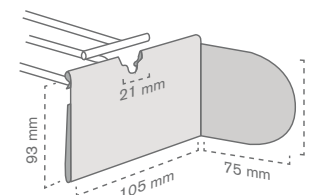

Ref.	Misure		Mat.	50	1000 u*
	Linguetta	Stopper			
10010401300	105 x 50 mm	75 x 75 mm	PVC	50	1000 u*



Regolatore fine corsa flessibile per gancio

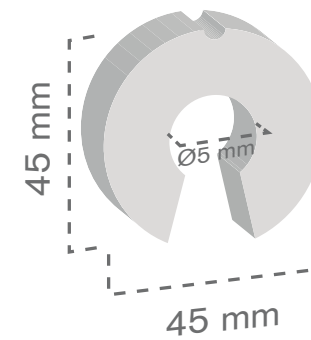

NEW



Regolatore fine corsa flessibile per gancio valido per diametri da 5 a 8 mm

Ref.	Misure	Colore		
10010403200	45 x 45 mm	BIANCO	100	100 u







Strisce e indicatori per profili

Strisce e indicatori per profili



Ref.	Misure	Mat.	Colore*		
10010500100	100 m x 40 mm	PVC	032 C	1	1 u

Striscia Pantone in rotolo.
Striscia da profilo monocolorre. Per altre misure e colori, richiederne la disponibilità.



Ref.	Misure	Mat.	Colore		
10010500200	665 x 30 mm	PVC	1 colore	100	1000 u
10010500300	665 x 40 mm	PVC	1 colore	100	1000 u
10010500400	665 x 50 mm	PVC	1 colore	100	1000 u

Striscia 1 colore.
Striscia da profilo personalizzabile in serigrafia a 1 colore.



Ref.	Misure	Mat.	Stampa		
10010500500	665 x 30 mm	PVC	Personalizzabile	100	1000 u
10010500600	665 x 40 mm	PVC	Personalizzabile	100	1000 u
10010500700	665 x 50 mm	PVC	Personalizzabile	100	1000 u

Striscia a 2 colori.
Modello personalizzabile con disegno e messaggio in serigrafia a 2 colori. In stampa digitale l'ordine minimo è di 250 unt.



Ref.	Misure	Mat.	Colore*		
10010500800	30 x 35 mm	PVC	485 C	200	200 u
10010500900	30 x 90 mm	PVC	485 C	200	200 u
10010501000	35 x 35 mm	PVC	485 C	200	200 u

Frecce segnalatrici.
Frecce segnalatrici colore Pantone di differenti tipologie e misure. Ideali per la segnalazione nel PV.

Strisce per profili



NEW

Ref.	Misure	Mat.		
10010502200	1200 m x 120 mm	PVC	1	1 u

Striscia
Striscia personalizzabile.



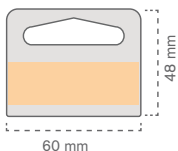

Fasce per cross merchandising

Blisters con **adesivo cellulosa**

Ref.	Misure	Mat.		
10010600100	60 x 48 mm	PVC TTE	1000	1000 u

Appendino blister 60 mm.

Appendino blister, progettato per favorire il posizionamento di articoli su una striscia da cross merchandising.

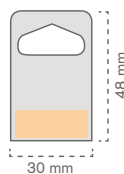

Ref.	Misure	Mat.		
10010600200	30 x 48 mm	PVC TTE	1000	1000 u

Appendino blister 30 mm.

Appendino adesivo per prodotti di dimensioni ridotte. Consigliato per posizionare articoli su una striscia da cross merchandising.

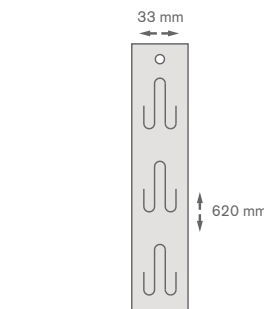
Fasce **standard** da cross merchandising

Ref.	Misure	Mat.		
10010601000	33 x 620 mm	PVC TTE	250	250 u

Fascia da cross merchandising di PVC per gancio.

Questo modello consente di posizionare fino a 11 articoli di piccola grandezza.

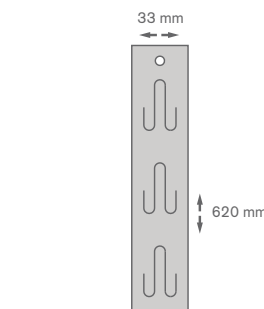



Ref.	Misure	Mat.		
10010601100	33 x 620 mm	PP Compatto bianco	250	250 u

Fascia da cross merchandising di PP per gancio.

Questo modello consente di posizionare fino a 11 articoli di piccola grandezza.

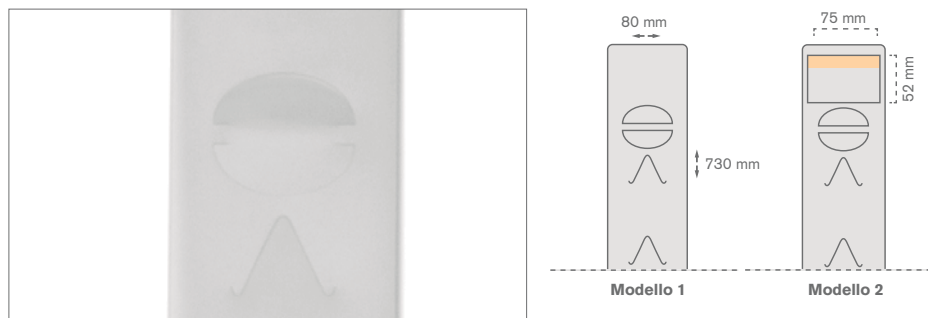
Fasce da cross merchandising per **complemento laterale**



Mod.	Ref.	Misure	Mat.		
1	10010600700	80 x 730 mm	PP Compatto	250	250 u
2	10010600800	80 x 730 mm	PP Compatto	250	250 u

Vedere sezione di complementi, modello laterale speciale per Fasce Cross.

Fascia da cross merchandising per laterale.

Fascia Cross per complemento laterale di testata. Disponibile con o senza tasca. Capacità per 6 unt.







Piedini e bandierine

72 Piedini e bandierine

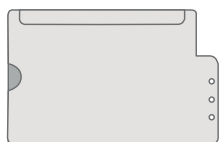
Bandierina con finitura **lucida**



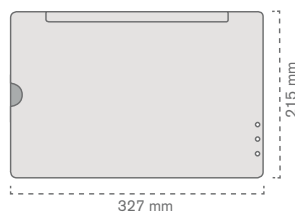

Ref.	Misure	Mat.		
10010700100	A5	PVC TTE	50	50 u
10010700200	A6	PVC TTE	50	50 u

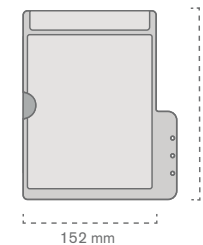

Ref.	Misure	Mat.		
10010700300	A4	PVC TTE	25	25 u





Ref.	Misure	Mat.		
10010700400	152 x 216 mm	PVC TTE	50	1000 u*

*Ordine minimo per serigrafia. Per stampa digitale, l'ordine minimo è di 250 unt.

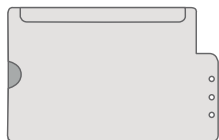
Bandierina con finitura **opaca**



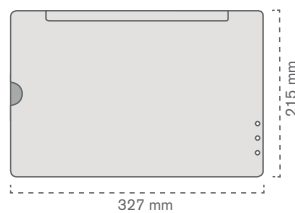

Ref.	Misure	Mat.		
10010700500	A5	PVC TTE	50	50 u
10010700600	A6	PVC TTE	50	50 u

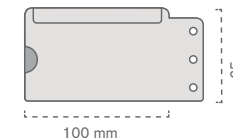

Ref.	Misure	Mat.		
10010700700	A4	PVC TTE	25	25 u

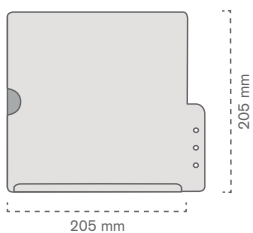

Ref.	Misure	Mat.		
10010700800	100 x 65 mm	PVC TTE	100	100 u

Bandierina con finitura **opaca**

Ref.	Misure	Mat.		
10010700900	205 x 205 mm	PVC TTE	50	50 u

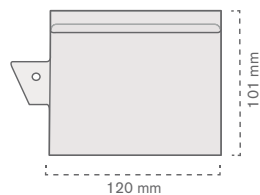
Bandierina **stopper** per pinza

Ref.	Misure	Mat.		
10010701000	120 x 101 mm	PVC TTE	100	100 u

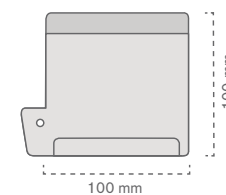
Bandierina stopper **personalizzata**

Ref.	Misure	Mat.		
10010701100	100 x 100 mm	PVC TTE	100	1000 u*

*Ordine minimo per serigrafia. Per stampa digitale, l'ordine minimo è di 250 unt.

Piedino da banco

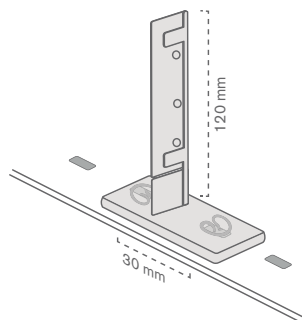

Ref.	Misure	Colore		
10010701200	48 x 25 x 120 mm	TTE	50	100 u

Piedino 30 mm. con clips.
Piedino per bandierine, applicabile su banchi con distanza fori a 30 mm.

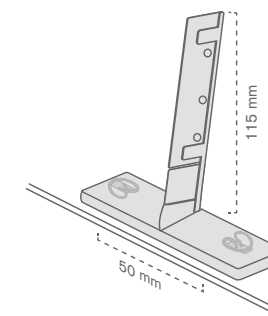

Ref.	Misure	Colore		
10010701400	75 x 25 x 115 mm	TTE	100	100 u

Piedino inclinato con clips.
Piedino inclinato per bandierine, applicabile su banchi con distanza fori a 50 mm.

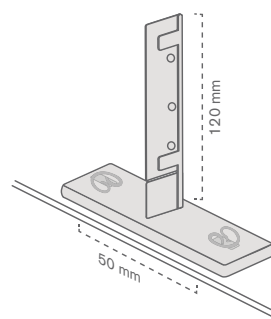

Ref.	Misure	Colore		
10010701300	75 x 25 x 120 mm	TTE	50	100 u

Piedino 50 mm. con clips.
Piedino per bandierine, applicabile su banchi con distanza fori a 50 mm.

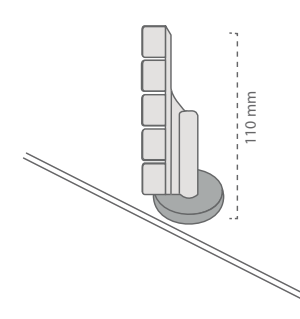

Ref.	Misure	Colore		
10010701500	40 x 40 x 110 mm	TTE	20	20 u

Piedino calamitato.
Piedino con base calamitata, ideale per posizionare bandierine su banchi metallici.

Piedino per **profili con etichetta elettronica**

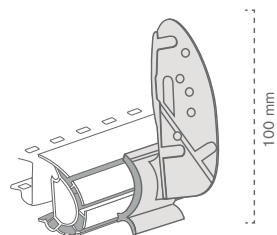

Ref.	Misure	Colore		
10010701600	20 x 40 x 100 mm	TTE	100	100 u

Piedino per profilo FL.
Modello appositamente progettato per profili FL.

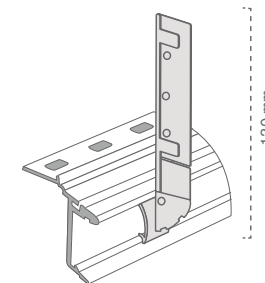

Ref.	Misure	Colore		
10010701800	23 x 45 x 130 mm	TTE	100	100 u

Piedino per profilo ETE.
Modello appositamente progettato per profili ETE.

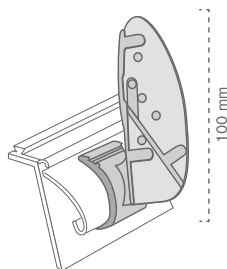

Ref.	Misure	Colore		
10010701700	20 x 50 x 100 mm	TTE	100	100 u

Piedino per profilo SlimLine.
Modello appositamente progettato per profili SlimLine.





Espositori

Espositore da lineare con **adesivo cellulosa**

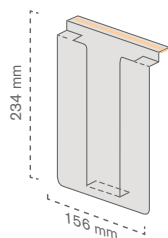

Ref.	Misure	Mat.		
10040600800	1/3 A4	PVC	50	50 u

Espositore da lineare per **profilo**

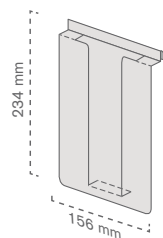

Ref.	Misure	Mat.		
10040600900	1/3 A4	PVC	50	50 u

Espositore da lineare con **profilo basculante**

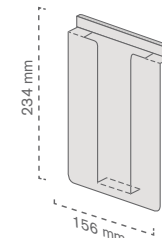

Ref.	Misure	Mat.		
10040601000	1/3 A4	PVC	25	25 u

Espositore di **piccoli prodotti** per lineare

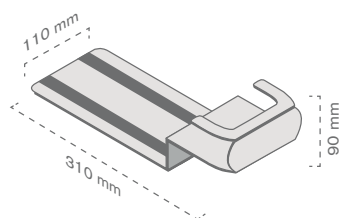

Ref.	Misure	Mat.		
1004050400	110 x 310 x 90 mm	PMMA TTE (3 mm)	10	10 u

Stampa non inclusa.

Espositore **inclinato**

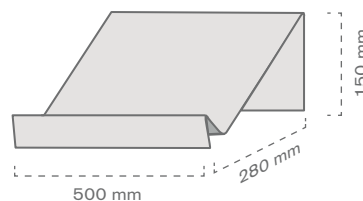

Ref.	Misure	Mat.		
10040504100	500 x 280 x 150 mm	PMMA TTE (5 mm)	6	6 u

Supporto **porta-schede**

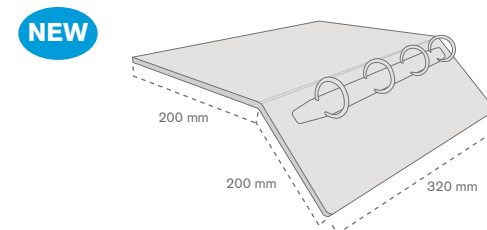

Ref.	Misure	Mat.		
10040551100	320 X 320 mm	V	6	6 u

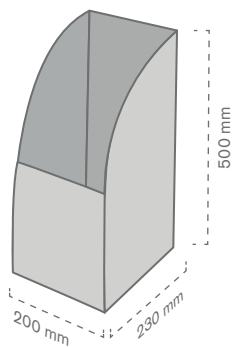
Espositore **Slim box**

Espositore contenitore di prodotti. Progettato per esporre e ospitare prodotti, specialmente quelli con forma allungata, facilitandone l'esposizione nel punto vendita.

Ref.	Misure	Mat.		
10040504200	200 x 230 x 500 mm	PP Cellulare (3,5 mm)	5	5 u

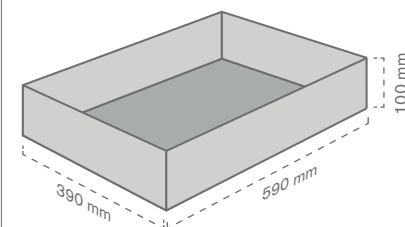
Cesta in vimini modello **L**



Cesta in vimini naturale dimensione L. Ideale per valorizzare e donare un tocco rustico e artigianale al prodotto.

Ref.	Misure	Mat.		
10040500200	390 x 590 x 100 mm	Vimini	5	5 u

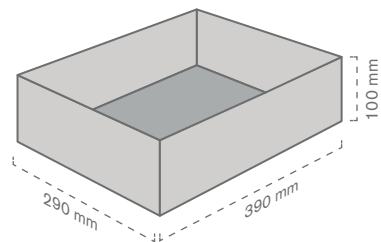
Cesta in vimini modello M



Cesta in vimini naturale dimensione M. Ideale per valorizzare e donare un tocco rustico e artigianale al prodotto.

Ref.	Misure	Mat.		
10040500300	290 x 390 x 100 mm	Vimini	5	5 u

Cesta in vimini **inclinata** modello M

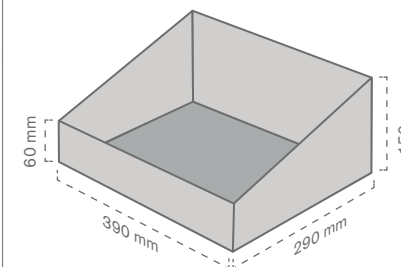

Cesta in vimini naturale inclinata dimensione M. Ideale per valorizzare e donare un tocco rustico e artigianale al prodotto.

Ref.	Misure	Mat.		
10040500400	390 x 290 x 150 mm	Vimini	5	5 u



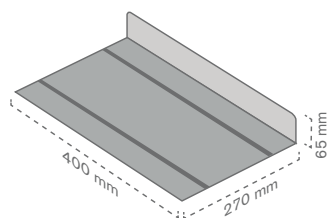

Bandelle promozionali

Bandella promozionale **standard**

Ref.	Misure	Mat.		
10010900100	400 x 270 x 65 mm	PVC BCO	4	4 u

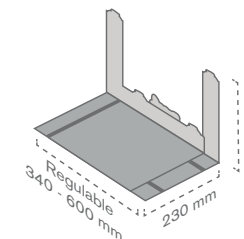
Bandella promozionale **doppia**

Ref.	Misure	Mat.		
10010900200	340/600 x 230 x 264 mm	PVC BCO	2	2 u

Bandella promozionale con stopper

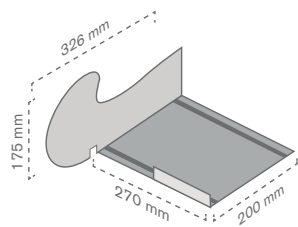

Ref.	Misure	Mat.		
10010900300	270 x 200 x 175 mm	PVC BCO	4	4 u



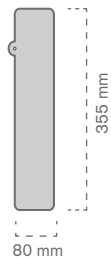

Separatori verticali

Separatore verticale **standard**

Ref.	Misure	Mat.		
10011000100	80 x 355 mm	PVC	100	1000 u*

*Ordine minimo per stampa in serigrafia. Per stampa digitale l'ordine minimo è di 14 unt.

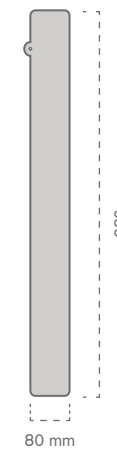

Ref.	Misure	Mat.		
10011000200	80 x 680 mm	PVC	100	1000 u*

*Ordine minimo per stampa in serigrafia. Per stampa digitale l'ordine minimo è di 6 unt.

Separatore verticale **standard**

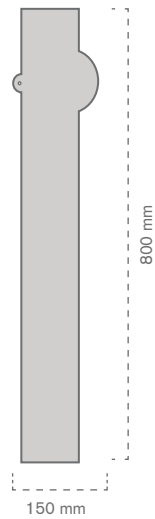

Ref.	Misure	Mat.		
10011000300	150 x 800 mm	PVC	50	1000 u *

*Ordine minimo per stampa in serigrafia. Per stampa digitale l'ordine minimo è di 4 unt.

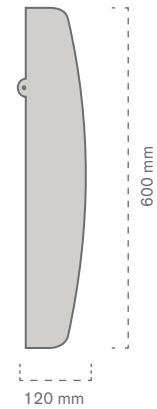

Ref.	Misure	Mat.		
10011000400	120 x 600 mm	PVC	100	1000 u *

*Ordine minimo per stampa in serigrafia. Per stampa digitale l'ordine minimo è di 7 unt.

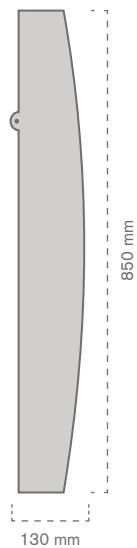
Separatore verticale **standard**

Ref.	Misure	Mat.		
10011000500	130 x 850 mm	PVC	50	1000 u*

*Ordine minimo per stampa in serigrafia. Per stampa digitale l'ordine minimo è di 4 unt.

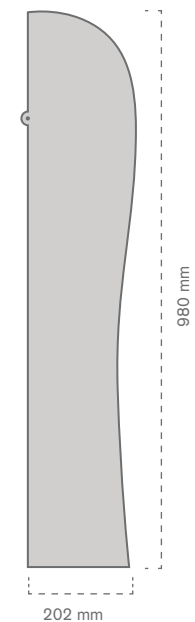

Ref.	Misure	Mat.		
10011000600	202 x 980 mm	PVC	50	1000 u*

*Ordine minimo per stampa in serigrafia. Per stampa digitale l'ordine minimo è di 3 unt.

Separatore verticale **standard**

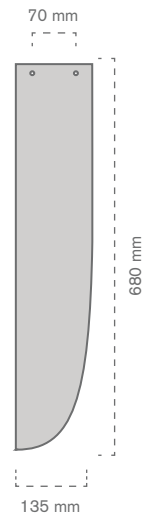

Ref.	Misure	Mat.		
10011000700	135 x 680 mm	PVC	100	1000 u*

*Ordine minimo per stampa in serigrafia. Per stampa digitale l'ordine minimo è di 7 unt.

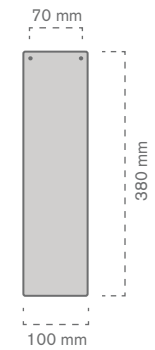

Ref.	Misure	Mat.		
10011000800	100 x 380 mm	PVC	100	1000 u*

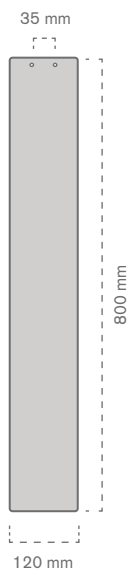

*Ordine minimo per stampa in serigrafia. Per stampa digitale l'ordine minimo è di 14 unt.

Separatore verticale **standard**

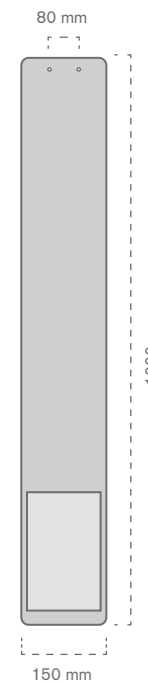

Ref.	Misure	Mat.		
10011000900	120 x 800 mm	PVC Espanso (3 mm)	50	50 u



Ref.	Misure		Mat.		
	Separatore	Display			
10011001000	150 x 1000 mm	A5	PVC Espanso (3 mm)	40	40 u

Separatore da banco con stopper

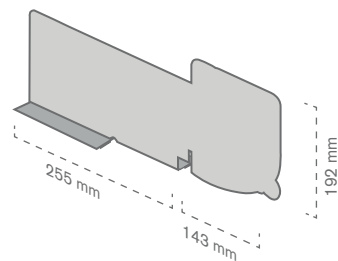

Separatore con stopper, dotato di doppia aletta calamitata per facilitarne il fissaggio al lineare.

Ref.	Misure		Mat.		
	Separatore	Stopper			
10011001100	255 x 150 mm	143 x 192 mm	PVC	100	1000 u*

*Ordine minimo per stampa in serigrafia. Per stampa digitale l'ordine minimo è di 6 unt.

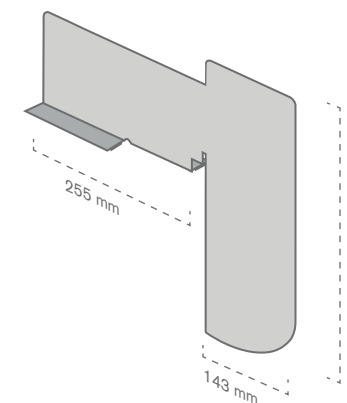

Modello di separatore con stopper allungato che, come il modello precedente, comprende una doppia aletta calamitata per facilitarne il fissaggio al ripiano.

Ref.	Misure		Mat.		
	Separatore	Stopper			
10011001200	255 x 150 mm	143 x 440 mm	PVC	100	1000 u*

*Ordine minimo per stampa in serigrafia. Per stampa digitale l'ordine minimo è di 4 unt.

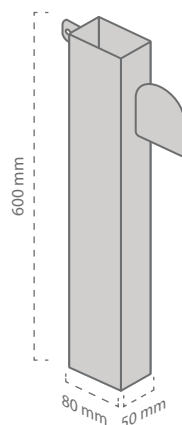
Separatore verticale con **stopper**

Separatore verticale 3D con stopper. Questo modello comprende un'aletta posteriore che ne consente la sospensione tramite pinza perforata per stopper.

Ref.	Misure		Mat.	🛒	📄
	Separatore	Stopper			
10011001300	50 x 80 x 600 mm	100 x 110 mm	PVC	25	25 u

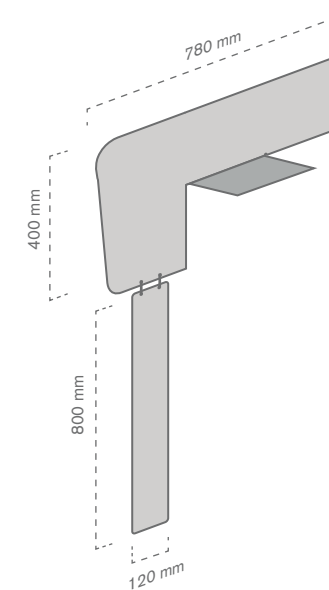
Separatore verticale **combinato**

Separatore verticale composto da due parti unite tramite anelli. Questo modello dispone di una doppia aletta magnetica che ne facilita il fissaggio sul ripiano.

Ref.	Misure		Mat.	🛒	📄
	Superiore	Inferiore			
10011001400	780 x 400 mm	120 x 800 mm	PVC Espanso (3 mm)	25	25 u

Ganci ed accessori

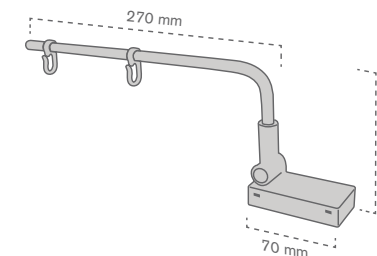

Ref.	Misure	Mat.		
10050101200	35 x 51 mm	PP Semitrasparente	100	100 u

Pinza stopper perforata.
Efficace per fissare stopper e separatori ai profili di linea-re.

Ref.	Misure		
10050300700	340 x 110 mm	10	10 u

Braccetto calamitato.
Supporto calamitato efficace per fissare separatori verticali al ripiano.

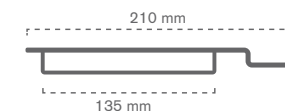
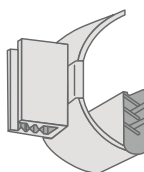
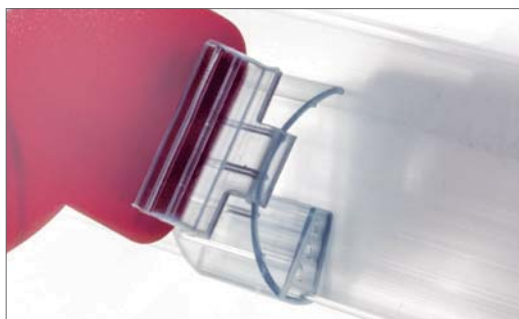

Ref.	Misure	Mat.		
10050101300	45 x 51 mm	PVC TTE	100	100 u

Pinza stopper regolabile.
La pinza regolabile permette di posizionare lo stopper a differenti altezze e angolazioni.

Ref.	Misure	Mat.	Colore		
10011001700	210 x 33 x 20 mm	Metallo	NERO	10	10 u

Supporto metallico.
Aggancio metallico dentellato, utile per fissare separatori verticali al ripiano.





False masse

100 False masse

Falsa massa **promozionale**

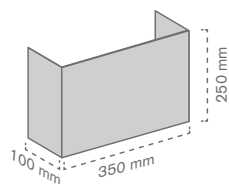

Ref.	Misure	Mat.		
10011100100	350 x 100 x 250 mm	PP Cellulare (3,5 mm)	35	35 u

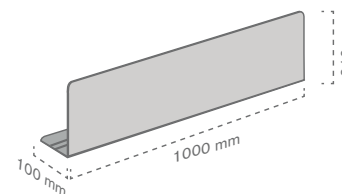

Falsa massa **orizzontale**

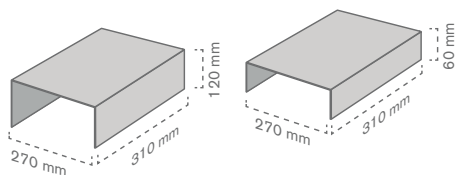

Ref.	Misure	Mat.		
10011100200	1000 x 100 x 210 mm	PVC Espanso (3 mm)	18	18 u

Falsa massa a gradino



Ref.	Misure	Mat.	Colore		
10011100300	270 x 310 x 120 mm	Metallo	NERO	6	6 u
10011100400	270 x 310 x 60 mm	Metallo	NERO	10	10 u





Cornici promozionali



Pure & Natural
diet

Pure & Natural
sugerfree

Pure & Natural
no gluten

Pure & Natural

Pure & Natural

- Oggi giorno la maggior parte delle decisioni d'acquisto si prendono nel punto vendita. Per questo, è importante che i prodotti si distinguano da quelli della concorrenza, distaccandosi a livello visivo, per incrementarne le vendite.

Le cornici promozionali e i portali lungo il lineare ottengono esattamente questo effetto, permettendo al prodotto di distinguersi dall'enorme varietà di prodotti presenti a banco.

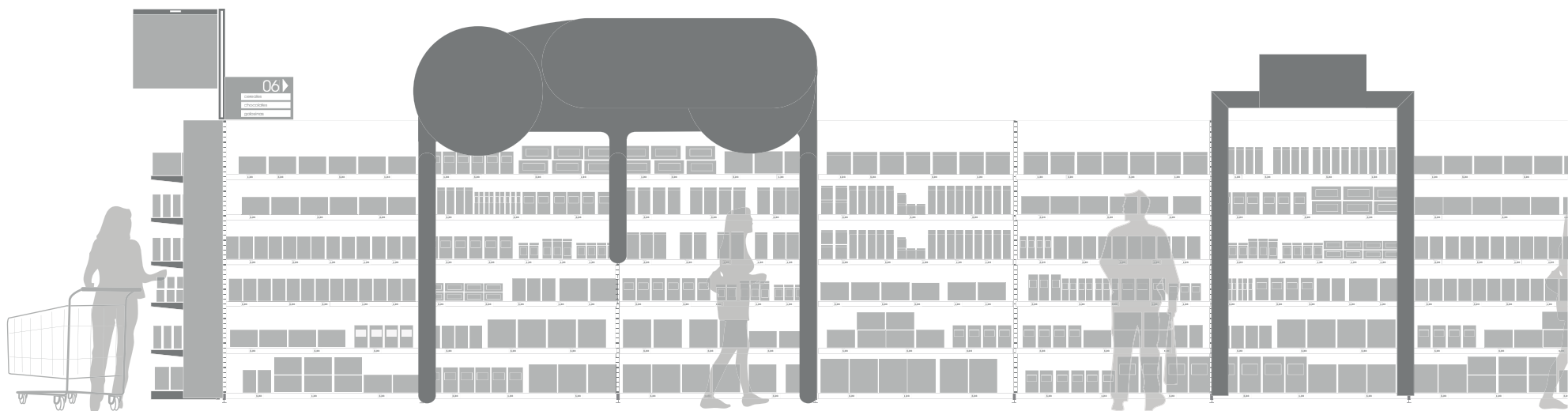

Applicazioni



Campagne lancio
e stagionali
o permanenti



Fidelizzazione



Promozione
di un marchio
o di una famiglia
di prodotti



Classificazione e
segmentazione
di prodotto

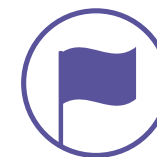

Tipicità regionali





Distacco
di categoria

106 Cornici promozionali

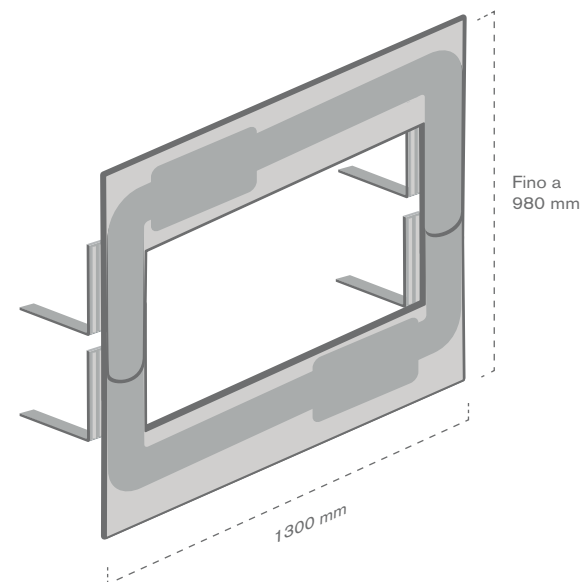
Cornice promozionale **regolabile 1300**



Cornice che permette di inquadrare da un estremo all'altro, un elemento di gondola. La sua struttura si compone di due parti regolabili in altezza, appoggiate al ripiano per mezzo di squadre posteriori.

Ref.	Misure		Mat.		
	Larghezza	Altezza			
10011200100	1300 mm	Fino a 980 mm	PVC Espanso (5 mm)	4	4 u

Cornice promozionale **regolabile 800**

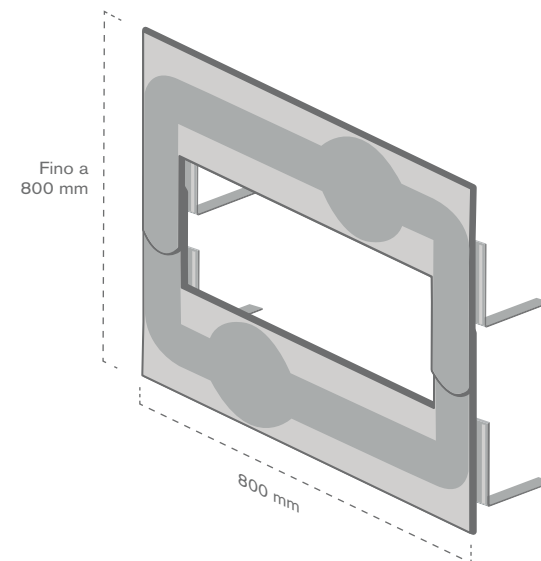

Cornice che permette di inquadrare da un estremo all'altro, un elemento di gondola. La sua struttura si compone di due parti regolabili in altezza, appoggiate al ripiano per mezzo di squadre posteriori.

Ref.	Misure		Mat.	🛒	📄
	Larghezza	Altezza			
10011200200	800 mm	Fino a 800 mm	PVC Espanso (5 mm)	9	9 u

108 Cornici promozionali

Cornice promozionale di **testata**

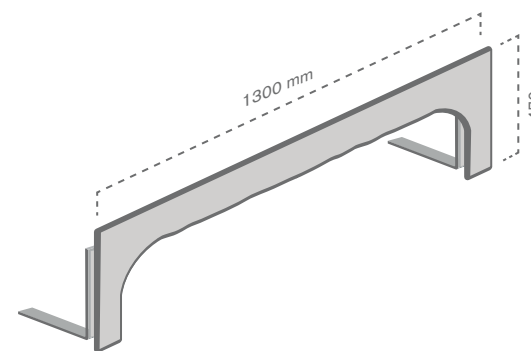

Cornice di testata particolarmente indicato per delimitare o distaccare sezioni del banco. Questo articolo si appoggia la banco per mezzo di squadre posteriori che si adattano al ripiano superiore dell'elemento di gondola.

Ref.	Misure		Mat.		
	Larghezza	Altezza			
10011200300	1300 mm	470 mm	PP Cellulare (5 mm)	10	10 u

Portale a 1 elemento

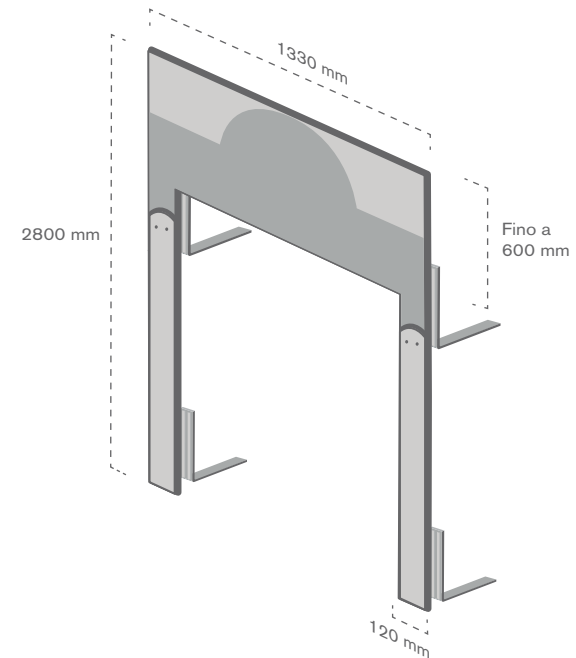

Portale progettato per evidenziare un elemento di gondola. La sua struttura è personalizzabile e si compone di due parti che si fissano al ripiano tramite squadre collocate nella parte posteriore.

Ref.	Misure		Mat.	🛒	📄
	Larghezza	Altezza			
10011200500	1330 mm	Fino a 2800 mm	PP Cellulare (5 mm)	1	1 u

110 Cornici promozionali

Portale a più elementi

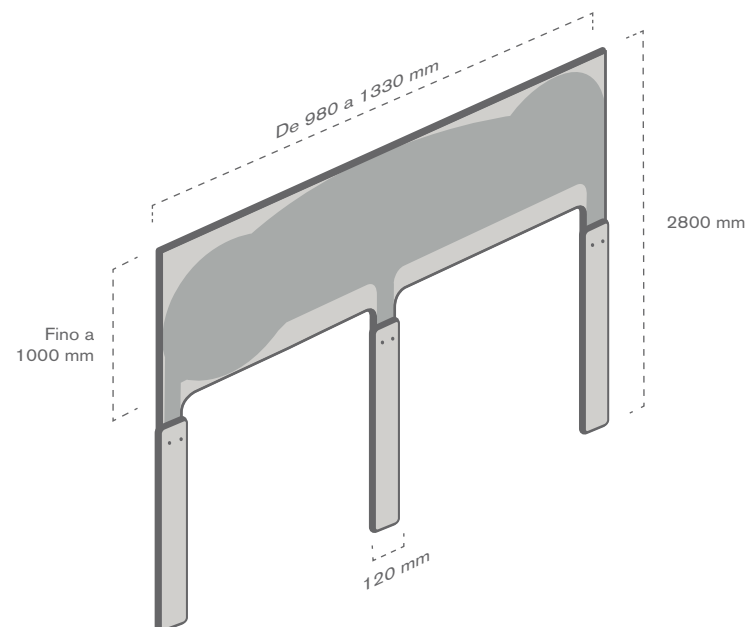

Il portale a più elementi unisce le caratteristiche del modello precedente col vantaggio di poter aggiungere nuovi elementi fino a coprire il tratto di lineare desiderato.

Ref.	Misure		Mat.	🛒	📄
	Larghezza	Altezza			
10011200600	1330 mm	Fino a 2800 mm	PP Cellulare (5 mm)	1	1 u

Mezzo portale

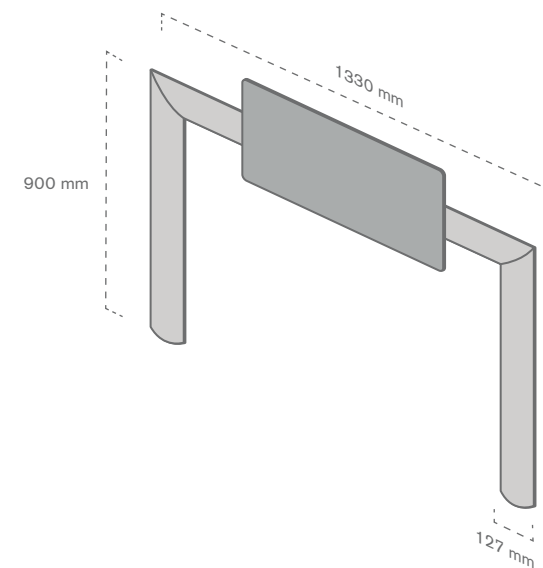

Cornice di struttura metallica, particolarmente indicato per delimitare mezza gondola. Permette l'aggiunta nella parte superiore di un cartello personalizzato in PVC espanso.

Ref.	Misure		Mat.	🛒	📄
	Larghezza	Altezza			
10011200700	1330 mm	900 mm + cartello	Metallo	1	1 u

112 Cornici promozionali

Portale a 1 elemento

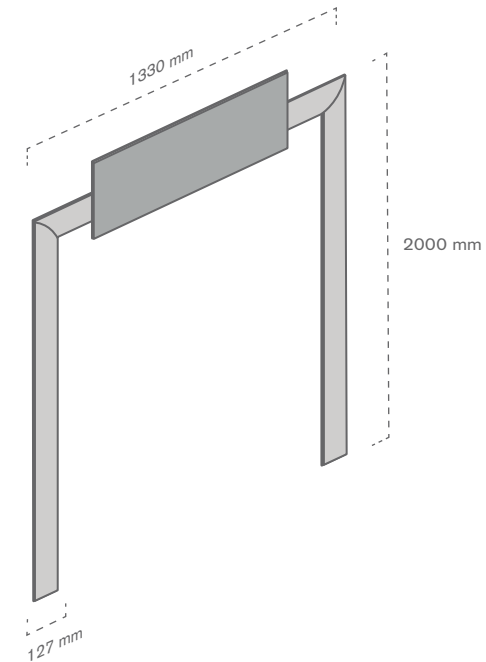

Portale con struttura metallica, specifico per un elemento di gondola. Come nel caso precedente, la struttura è provvista nella sua parte superiore di un cartello personalizzabile in PVC espanso.

Ref.	Misure		Mat.	🛒	📄
	Larghezza	Altezza			
10011200800	1330 mm	2000 mm + cartello	Metallo	1	1 u

Portale a più elementi

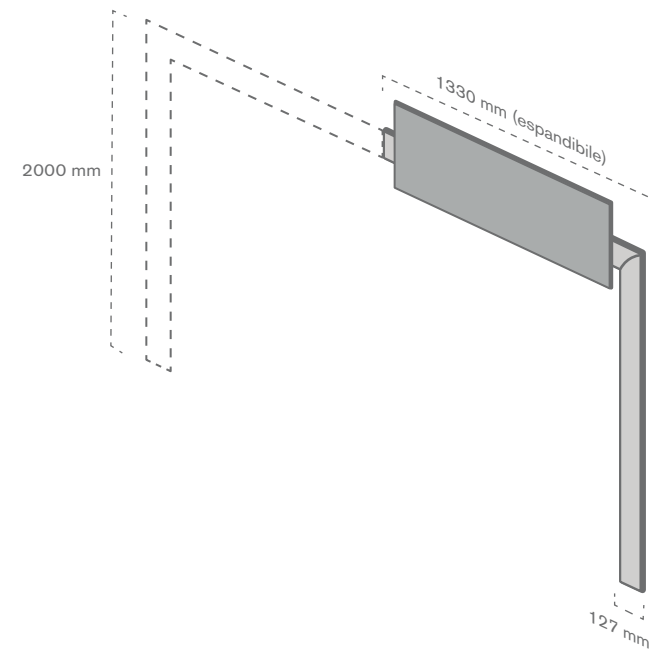

Portale con struttura metallica a più elementi. Questo modello ha il vantaggio di consentire di ampliare la superficie di copertura a multipli di 1330 mm. (dimensione degli elementi di gondola).

Ref.	Misure		Mat.	🛒	📄
	Larghezza	Altezza			
10011200900	1330 mm	2000 mm + cartello	Metallo	1	1 u

114 Cornici promozionali

Portale a 1 elemento

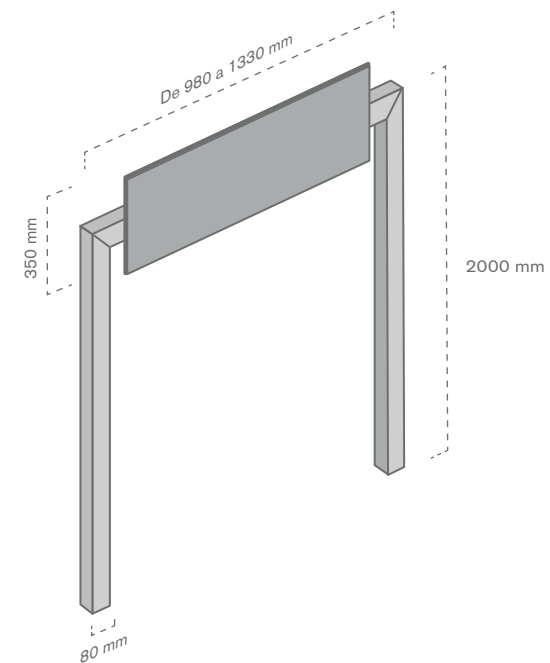

Portale fisso delle dimensioni di un elemento di gondola. Questo modello è realizzato in PVC ad alto impatto decorato con vinile laminato, che consente la stampa di qualsiasi disegno.

Ref.	Misure		Mat.	🛒	📄
	Larghezza	Altezza			
10011201000	1330 mm	2000 mm + cartello	PVC Alto Impatto	1	1 u

Portale a più elementi

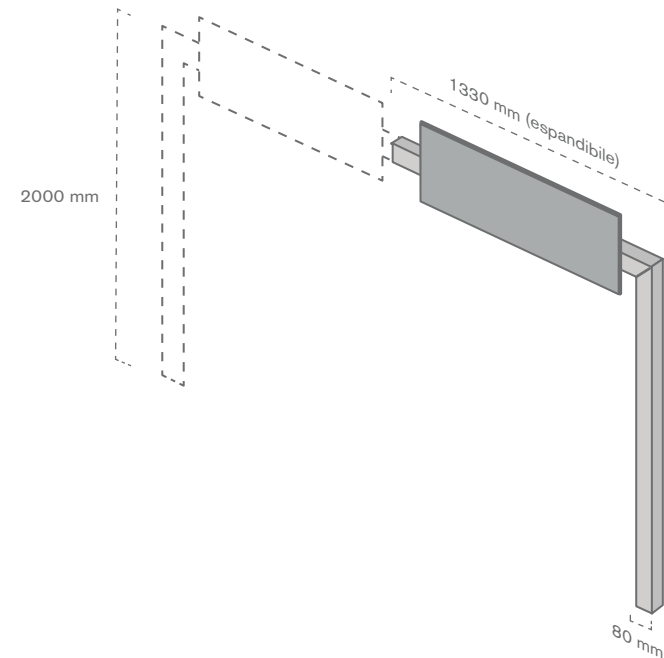

Portale a più elementi realizzato in PVC ad alto impatto, decorato con vinile laminato. Questo modello consente di ampliare la superficie di copertura grazie all'inserimento di sezioni larghe quanto un elemento di gondola.

Ref.	Misure		Mat.	🛒	📄
	Larghezza	Altezza			
10011201100	1330 mm	2000 mm + cartello	PVC Alto Impatto	1	1 u



“Facile e rapido da installare”



“Permette l’aggiunta di elementi complementari (LED, cartellonistica)...”

“Larghezza e altezza adattabili: elementi di gondola, lineari completi, mezze altezze...”



“100% stampabile e personalizzabile,
é possibile combinare forme, colori,
materiali e dimensioni diverse”



Nota legale: La presenza di brands terzi in questo catalogo, hanno valore puramente illustrativo e non hanno pertanto funzioni promozionali.

“La durabilità varia in funzione del materiale”







Copri pallet

120 Copri pallet

Copri pallet **metallico**

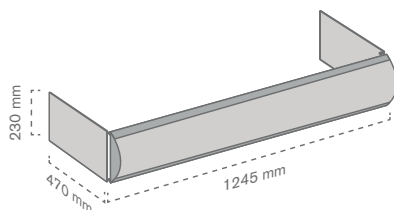

Ref.	Misure	Mat.	Colore		
10011300100	1245 x 470 x 230 mm	Metallo	NERO	1	10 u

Stampa non inclusa.

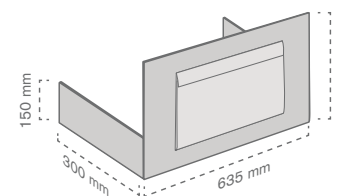

Ref.	Misure		Mat.	Colore		
	Generale	Tasca				
10011300200	635 x 300 x 500 mm	A3	Metallo	RAL 3020	1	10 u

Copri pallet in polipropilene

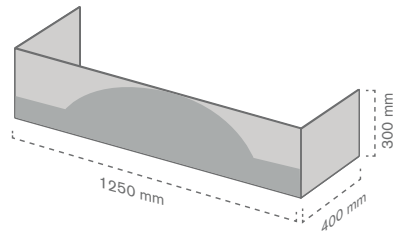

Ref.	Misure	Mat.	Colore		
10011300500	1250 x 400 x 300 mm	PP Cellulare (3,5 mm)	BIANCO	6	6 u

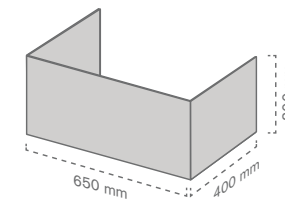



Ref.	Misure	Mat.	Colore		
10011300900	650 x 400 x 300 mm	PP Cellulare (3,5 mm)	BIANCO	12	12 u

122 Copri pallet

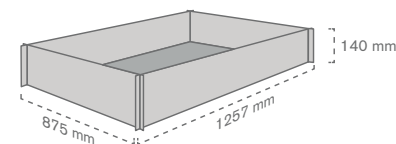
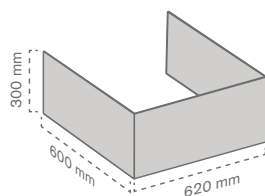
Copri pallet in **polipropilene**



Ref.	Misure	Mat.	Colore		
10011301300	620 x 600 x 300 mm	PP Cellulare (3,5 mm)	BIANCO	9	9 u

Ref.	Misure	Mat.	Colore		
10011300300	1257 x 875 x 140 mm	PP Cellulare (3,5 mm)	BIANCO	8	8 u





Divisori

Separatore con **frontale sinistro**

Ref.	Misure	Colore		
10011401300	385 x 120 mm	TTE	25	25 u
10011401400	285 x 120 mm	TTE	25	25 u
10011401500	185 x 120 mm	TTE	25	25 u
10011401600	385 x 60 mm	TTE	25	25 u
10011401700	285 x 60 mm	TTE	25	25 u
10011401800	185 x 60 mm	TTE	50	50 u

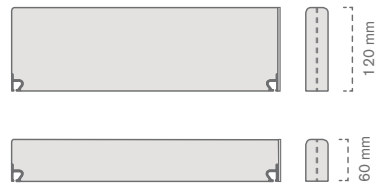
Separatore con **frontale centrale**

Ref.	Misure	Colore		
10011400700	385 x 120 mm	TTE	25	25 u
10011400800	285 x 120 mm	TTE	25	25 u
10011400900	185 x 120 mm	TTE	25	25 u
10011401000	385 x 60 mm	TTE	25	25 u
10011401100	285 x 60 mm	TTE	25	25 u
10011401200	185 x 60 mm	TTE	50	50 u

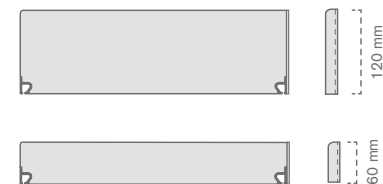
Separatore con **frontale destro**

Ref.	Misure	Colore		
10011400100	385 x 120 mm	TTE	25	25 u
10011400200	285 x 120 mm	TTE	25	25 u
10011400300	185 x 120 mm	TTE	25	25 u
10011400400	385 x 60 mm	TTE	25	25 u
10011400500	285 x 60 mm	TTE	25	25 u
10011400600	185 x 60 mm	TTE	50	50 u

Organizzatore **standard** con fissaggio

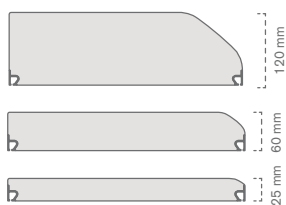
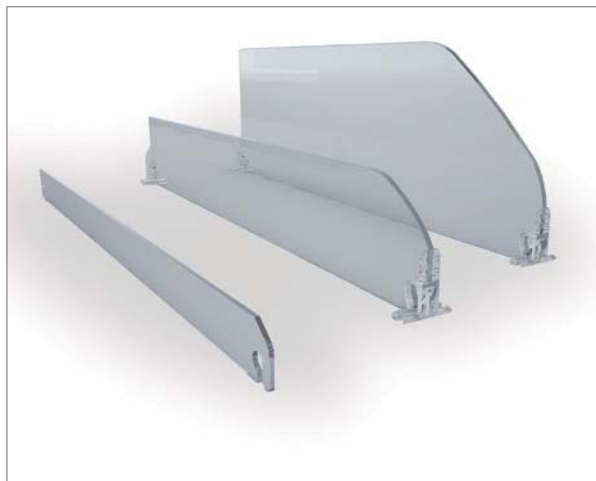

Ref.	Misure	Colore		
10011401900	385 x 120 mm	TTE	25	25 u
10011402000	285 x 120 mm	TTE	25	25 u
10011402100	185 x 120 mm	TTE	25	25 u
10011402200	385 x 60 mm	TTE	25	25 u
10011402300	285 x 60 mm	TTE	25	25 u
10011402400	185 x 60 mm	TTE	25	25 u
10011405600	385 x 25 mm	TTE	25	25 u

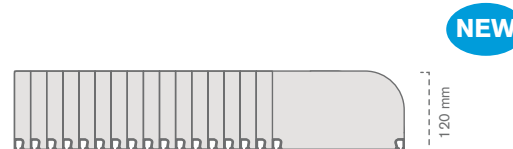
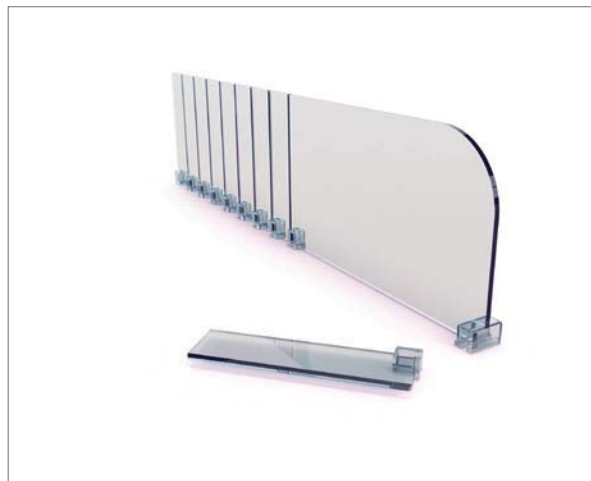

Separatore **frazionabile** con fissaggio



Ref.	Misure	Colore		
10011405500	120 x 185-585 mm	TTE	25	25 u

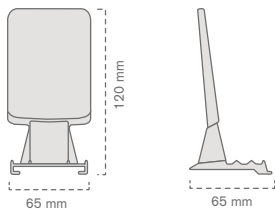

Supporto avanzamento del prodotto

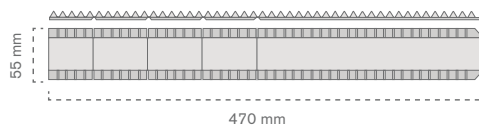
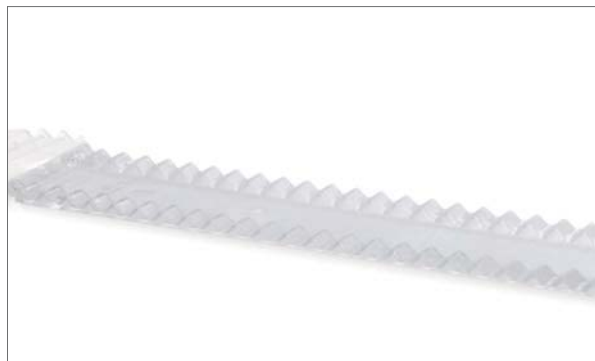

Ref.	Misure	Colore		
10011402600	65 x 120 mm	TTE	25	25 u

Corsia



Ref.	Misure	Colore		
10011402500	470 x 55 mm	TTE	25	25 u

Profilo posteriore

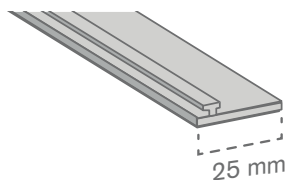

Con calamita adesiva

Ref.	Misure	Mat.		
10011403800	1330 mm	PVC BCO	25	25 u
10011403700	1245 mm	PVC BCO	25	25 u
10011402700	1000 mm	PVC BCO	25	25 u

Con adesivo spuma

Ref.	Misure	Mat.		
10011403801	1330 mm	PVC BCO	25	25 u
10011403702	1245 mm	PVC BCO	25	25 u
10011402701	1000 mm	PVC BCO	25	25 u

NEW

Profilo frontale

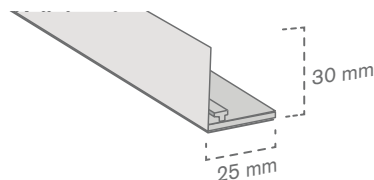

Con calamita adesiva

Ref.	Misure	Mat.		
10011403900	1330 mm	PVC BCO	25	25 u
10011402900	1245 mm	PVC BCO	25	25 u
10011402903	1000 mm	PVC BCO	25	25 u

Con adesivo spuma

Ref.	Misure	Mat.		
10011403901	1330 mm	PVC BCO	25	25 u
10011402902	1245 mm	PVC BCO	25	25 u
10011402904	1000 mm	PVC BCO	25	25 u

NEW

Profilo curvo con T

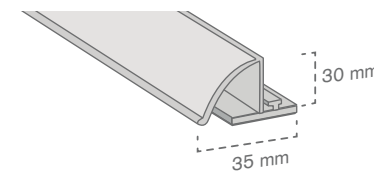

Con calamita adesiva

Ref.	Misure	Mat.		
10011403203	1330 mm	PVC BCO	10	10 u
10011403202	1245 mm	PVC BCO	10	10 u
10011403200	1000 mm	PVC BCO	10	10 u

Con adesivo spuma

Ref.	Misure	Mat.		
10011403204	1330 mm	PVC BCO	10	10 u
10011403205	1245 mm	PVC BCO	10	10 u
10011403206	1000 mm	PVC BCO	10	10 u

NEW









Profili

134 Profili

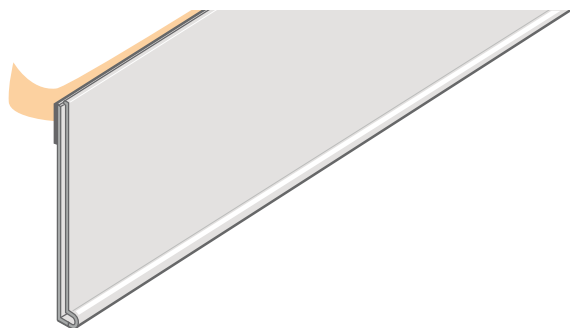
Profilo **DBR** con adesivo **cellulosa**



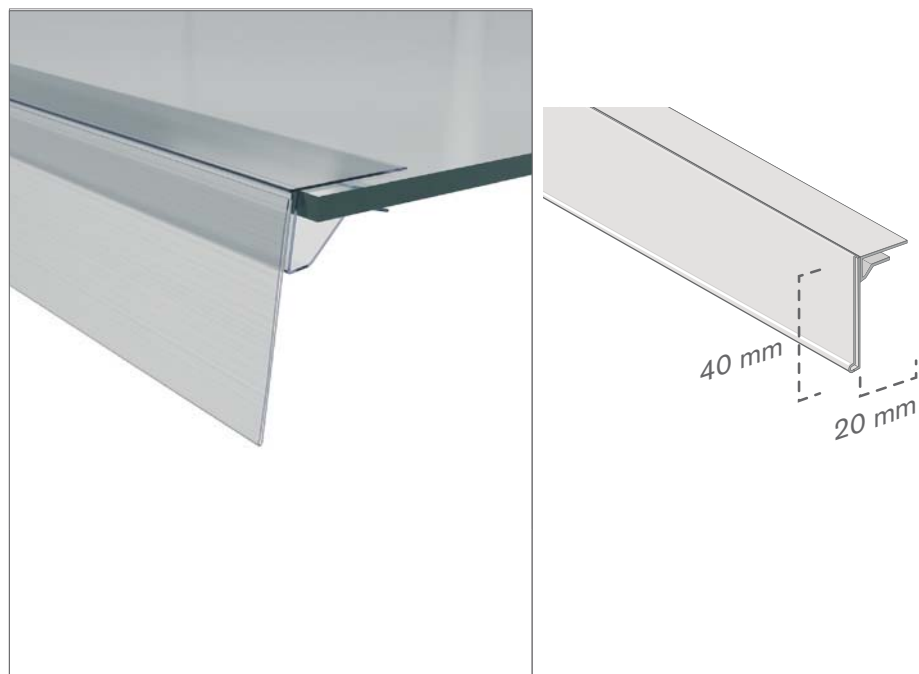

Ref.	Misure	Mat.	Adesivi		
10011501100	1320 x 100 mm	PVC TTE	1	50	1136 u
10011501300	1320 x 60 mm	PVC TTE	1	50	1136 u
10011501400	1320 x 40 mm	PVC TTE	1	50	50 u
10011501500	1320 x 30 mm	PVC TTE	1	50	1136 u
10011503800	1320 x 20 mm	PVC TTE	1	50	50 u
NEW 10011501200	1320 x 100 mm	PVC BCO	1	50	1136 u
10011501900	1320 x 60 mm	PVC BCO	1	50	1136 u
10011502000	1320 x 40 mm	PVC BCO	1	50	50 u
10011502100	1320 x 30 mm	PVC BCO	1	50	1136 u
10011503900	1320 x 20 mm	PVC BCO	1	50	50 u

Pinza **crystal** con **DBR**





Kit composto da pinza crystal con profilo DBR. Permette di posizionare un profilo DBR su ripiani di spessore compreso tra 8 e 10 mm.

Ref.	Misure	Mat.		
10011504100	1000 x 40 mm	PVC TTE	50	50 u
10011504000	1000 x 20 mm	PVC TTE	50	50 u

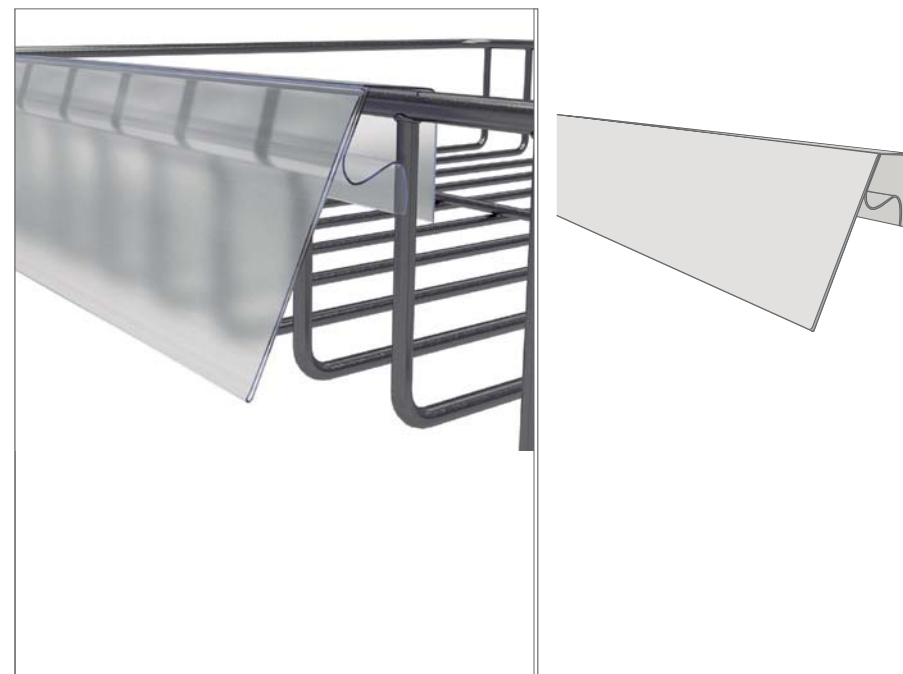

Pinza **ceste** con **DBR**



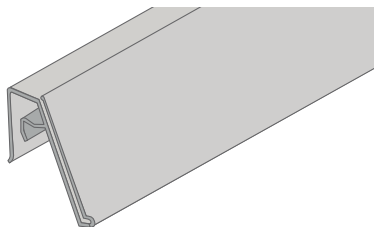

Kit con pinza e profilo DBR. Questo modello permette di posizionare il profilo DBR sulle cremagliere.

Ref.	Misure	Mat.		
10011503300	1000 x 40 mm	PVC TTE	50	1500 u
10011503100	1000 x 20 mm	PVC TTE	50	1500 u

Profilo per **ceste**

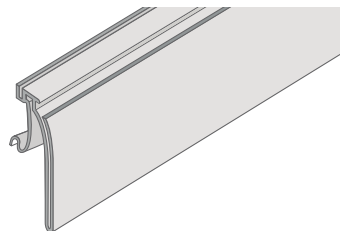
Ref.	Misure	Mat.		
10011502900	1000 x 50 mm	PVC BCO	50	1500 u

Profilo **basculante Hermes**

Ref.	Misure	Mat.		
10011502700	1320 x 40 mm	PVC TTE	50	1136 u
10011502800	1320 x 40 mm	PVC BCO	50	1136 u

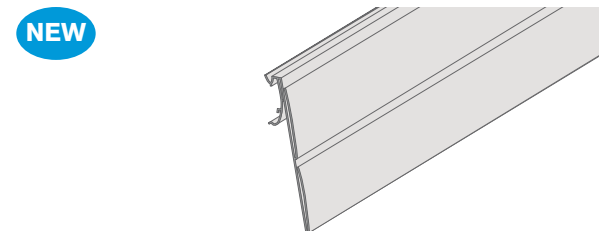
Profilo **basculante con tasca per banchi Hermes**

Ref.	Misure	Mat.		
10011505400	1320 x 40 mm	PVC TTE	50	50 u

Profilo posteriore

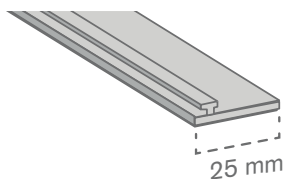

Con calamita adesiva

Ref.	Misure	Mat.		
10011403800	1330 mm	PVC BCO	25	25 u
10011403700	1245 mm	PVC BCO	25	25 u
10011402700	1000 mm	PVC BCO	25	25 u

Con adesivo spuma

Ref.	Misure	Mat.		
10011403801	1330 mm	PVC BCO	25	25 u
10011403702	1245 mm	PVC BCO	25	25 u
10011402701	1000 mm	PVC BCO	25	25 u

NEW

Profilo frontale

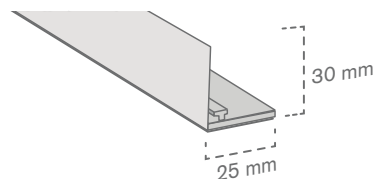

Con calamita adesiva

Ref.	Misure	Mat.		
10011403900	1330 mm	PVC BCO	25	25 u
10011402900	1245 mm	PVC BCO	25	25 u
10011402903	1000 mm	PVC BCO	25	25 u

Con adesivo spuma

Ref.	Misure	Mat.		
10011403901	1330 mm	PVC BCO	25	25 u
10011402902	1245 mm	PVC BCO	25	25 u
10011402904	1000 mm	PVC BCO	25	25 u

NEW

Profilo curvo con T

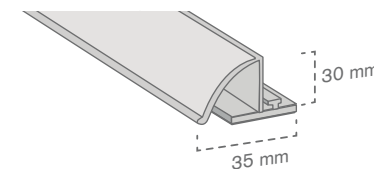

Con calamita adesiva

Ref.	Misure	Mat.		
10011403203	1330 mm	PVC BCO	10	10 u
10011403202	1245 mm	PVC BCO	10	10 u
10011403200	1000 mm	PVC BCO	10	10 u

Con adesivo spuma

Ref.	Misure	Mat.		
10011403204	1330 mm	PVC BCO	10	10 u
10011403205	1245 mm	PVC BCO	10	10 u
10011403206	1000 mm	PVC BCO	10	10 u

NEW

Profilo **DBR** doppio

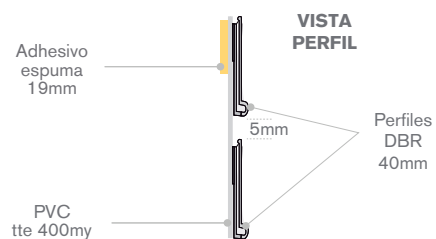
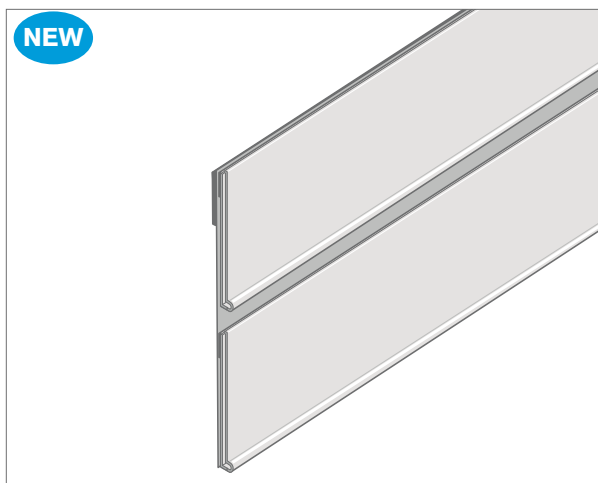

Ref.	Misure	Mat.	Adesivo		
10011508000	1160 x 85 mm	PVC TTE	1	50	50 u

Profilo **doppio basculante con DBR**

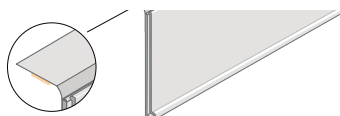

Ref.	Misure	Mat.		
10011502600	1320 x 40 mm	PVC TTE	50	50 u
10011502500	1320 x 20 mm	PVC TTE	50	50 u

Profilo **DBR basculante**

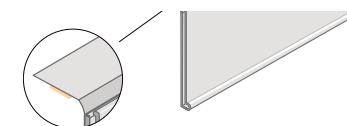

Ref.	Misure	Mat.		
10011504300	1320 x 55 mm	PVC TTE	50	50 u

Profilo **Universale** e complementi

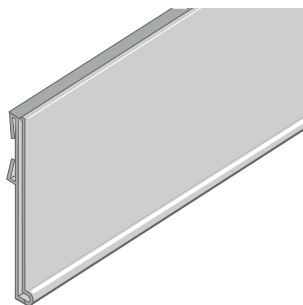

Ref.	Misure	Mat.		
10011503400	1000 x 39 mm	PVC TTE	100	1500 u

Profilo Universale.
 Profilo che, combinato ai suoi complementi, può adattarsi a una grande varietà di banchi.

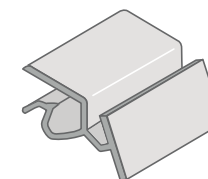

Ref.	Misure	Mat.		
10011503600	Ripiani da 6-8 mm	PVC TTE	100	3000 u

Pinza Glass Clip.
 Pinza progettata per frontali in vetro con spessore da 6 a 8 mm.

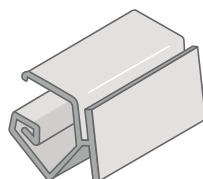

Ref.	Misure	Mat.		
10011503500	Ripiani fino a 20 mm	PVC TTE	100	3000 u

Pinza Grip Clip.
 Pinza consigliata per ripiani in legno alti fino a 20 mm.

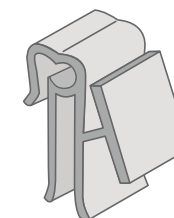
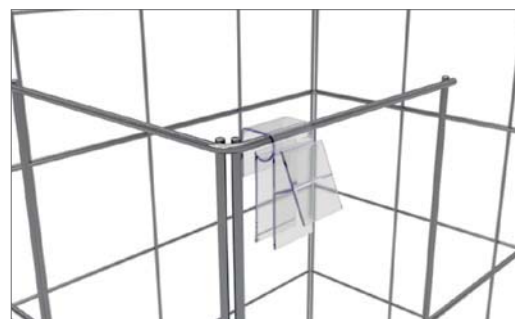

Ref.	Misure	Mat.		
10011503700	Ø 6-8 mm	PVC TTE	100	3000 u

Pinza Wire Clip.
 Pinza per ceste o barre con diametro compreso tra 6 e 8 mm.

Breakfast

What you should eat

- apples
- plums
- oranges
- pears
- nectarines

fruits

- plums
- oranges
- pears
- nectarines

eat bananas!

eat pears!

eat plums!

eat lemons!

eat nectarines!

eat mandarins!

eat apples!

eat apples!

eat apples!



oranges from VALENCIA
0,99 €/kg

special offer:
green apples
1,25 €/kg

oranges from VALENCIA
0,99 €/kg

Do you know about apples...?
One medium apple with skin contains 0.57 grams of protein, 95 calories, and 4.1 grams of dietary fiber.

Do you know about apples...?
One medium apple with skin contains 0.57 grams of protein, 95 calories, and 4.1 grams of dietary fiber.

Do you know about nectarines...?
One medium nectarine with skin contains 0.57 grams of protein, 95 calories, and 4.1 grams of dietary fiber.

fruit chocolates

fruit chocolates

fruit chocolates

fruit crackers

fruit crackers

DI

natural

Soluzioni porta comunicazioni

Tasche
Porta messaggi da tavolo
Telescopici e cornici
Piede Americano
Porta messaggi IFCO
Base pato
Porta messaggi per reparti







Tasche

144 Tasche

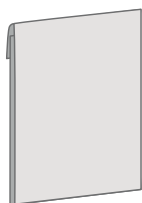

Tasca **verticale standard** opaca



Ref.	Misure	Mat.		
10020100100	A3	PVC	10	10 u
10020100200	A4	PVC	25	25 u
10020100300	A5	PVC	50	50 u
10020100400	A6	PVC	100	100 u
10020100500	A7	PVC	100	100 u

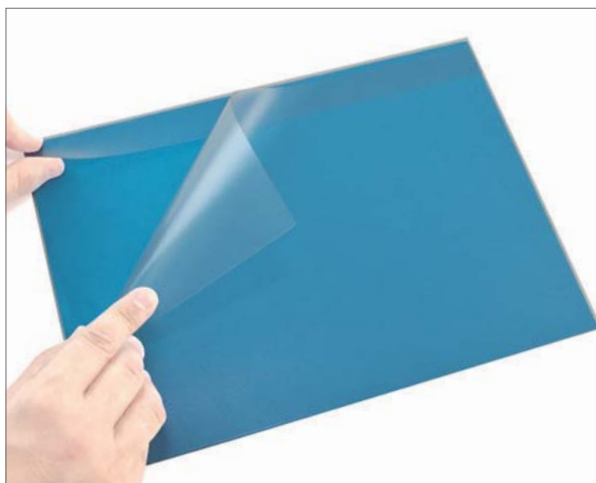

Tasca **orizzontale standard** opaca

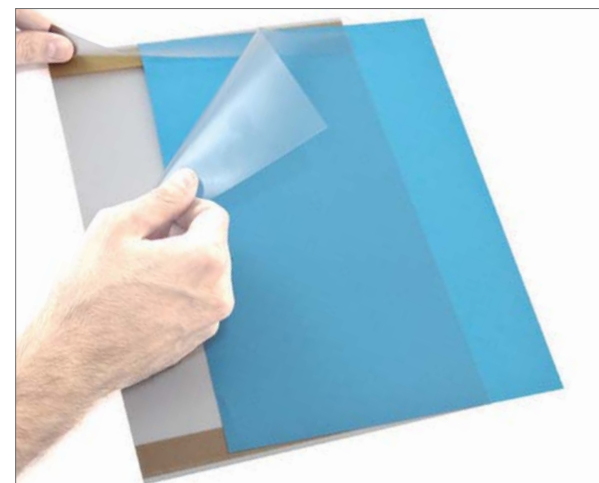

Ref.	Misure	Mat.		
10020100600	A3	PVC	10	10 u
10020100700	A4	PVC	25	25 u
10020100800	A5	PVC	50	50 u
10020100900	A6	PVC	100	100 u
10020101000	A7	PVC	100	100 u

Tasca **verticale** opaca con adesivo **cellulosa**



Ref.	Misure	Mat.		
10020101100	A3	PVC	10	10 u
10020101200	A4	PVC	25	25 u
10020101300	A5	PVC	50	50 u
10020101400	A6	PVC	100	100 u
10020101500	A7	PVC	100	100 u

Tasca **orizzontale** opaca con adesivo **cellulosa**

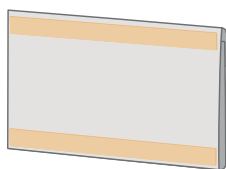
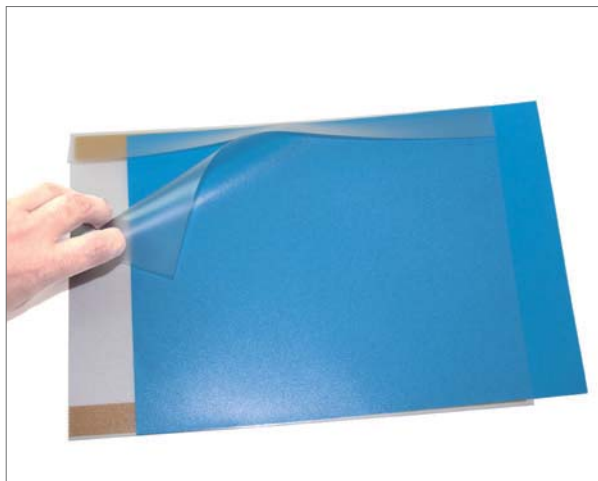

Ref.	Misure	Mat.		
10020101600	A3	PVC	10	10 u
10020101700	A4	PVC	25	25 u
10020101800	A5	PVC	50	50 u
10020101900	A6	PVC	100	100 u
10020102000	A7	PVC	100	100 u

Tasca **verticale** opaca **calamitata**



Ref.	Misure	Mat.		
10020102100	A3	PVC	10	10 u
10020102200	A4	PVC	25	25 u
10020102300	A5	PVC	50	50 u
10020102400	A6	PVC	100	100 u
10020102500	A7	PVC	100	100 u

Tasca **orizzontale** opaca **calamitata**

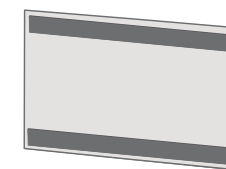
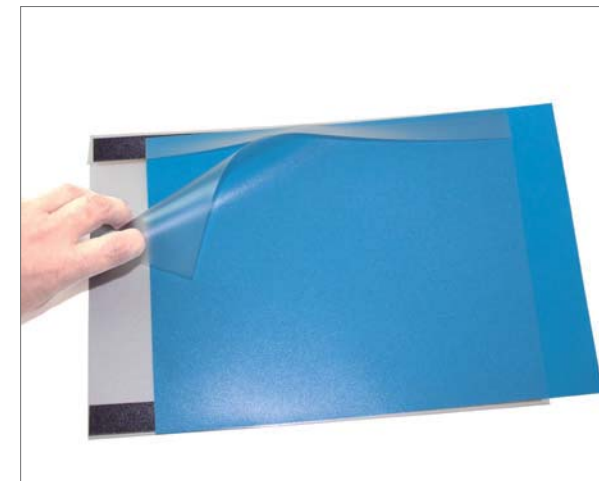

Ref.	Misure	Mat.		
10020102600	A3	PVC	10	10 u
10020102700	A4	PVC	25	25 u
10020102800	A5	PVC	50	50 u
10020102900	A6	PVC	100	100 u
10020103000	A7	PVC	100	100 u

146 Tasche

Tasca **verticale** opaca con **fori**

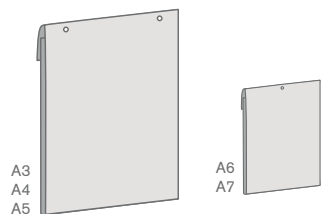

Ref.	Misure	Mat.		
10020103100	A3	PVC	10	10 u
10020103200	A4	PVC	25	25 u
10020103300	A5	PVC	50	50 u
10020103400	A6	PVC	100	100 u
10020103500	A7	PVC	100	100 u

Tasca **orizzontale** opaca con **fori**

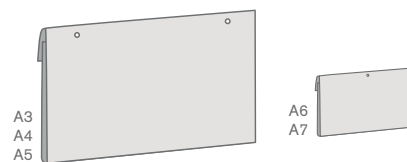

Ref.	Misure	Mat.		
10020103600	A3	PVC	10	10 u
10020103700	A4	PVC	25	25 u
10020103800	A5	PVC	50	50 u
10020103900	A6	PVC	100	100 u
10020104000	A7	PVC	100	100 u

Tasca orizzontale opaca con **occhielli metallici**

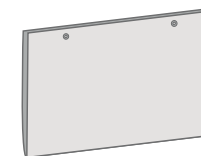

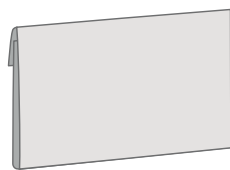
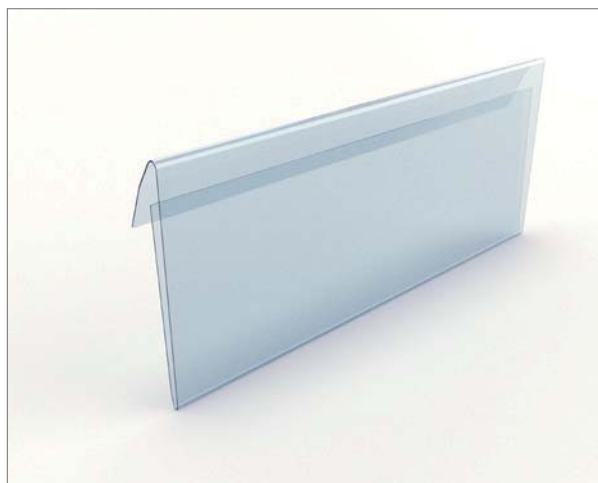

Ref.	Misure	Mat.		
10020104100	A3	PVC	25	25 u
10020104200	A4	PVC	25	25 u

Display 1/3 A4





NEW

Ref.	Misure	Mat.		
10020106100	215 x 105 mm	PVC	25	25 u

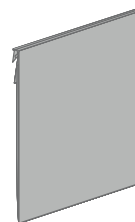
Display verticale con **profilo Basculante**





NEW

Ref.	Misure	Mat.		
10020106200	A7	PVC	25	25 u

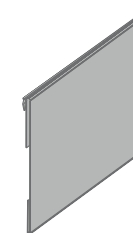
Display orizzontale con **profilo Basculante**



NEW

Ref.	Misure	Mat.		
10020106300	A6 (150x 105 mm)	PVC	25	25 u
10020106400	A7 (107 x 75 mm)	PVC	25	25 u
10020106500	A8 (75 x 53 mm)	PVC	25	25 u



148 Tasche

Display cornice **Nera**

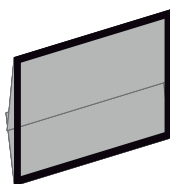

NEW





Ref.	Misure	Mat.		
10020106600	A5	PVC	50	50 u
10020106700	A7	PVC	50	50 u

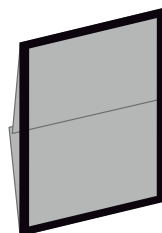

NEW





Ref.	Misure	Mat.		
10020106800	A6	PVC	50	50 u

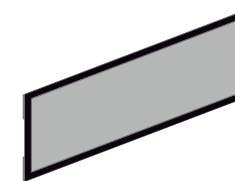

NEW



Ref.	Misure	Mat.		
10020106900	105 x 40 mm	PVC	50	50 u

Display **metacrilato** sospeso

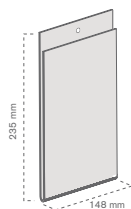

NEW

Ref.	Misure	Mat.		
10020107000	A5 (150 x 210 mm)	PMMA (2 mm)	10	10 u

Display verticale per **profili**

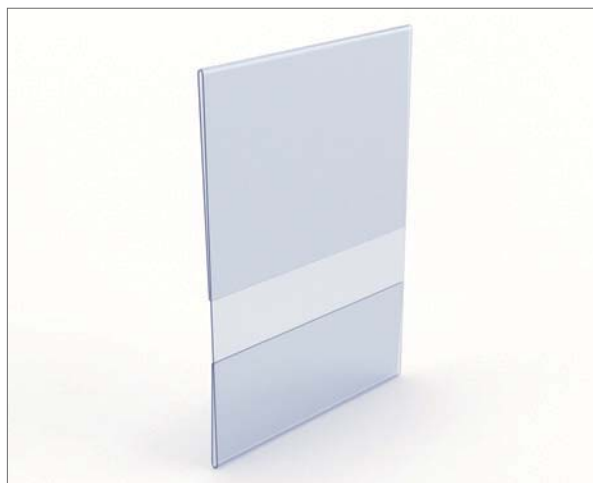

NEW

Ref.	Misure	Mat.		
10020107100	A8 (53 x 75 mm)	PVC	25	25 u

Display porta **display**

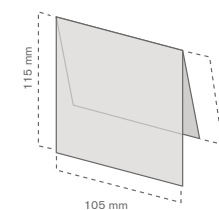
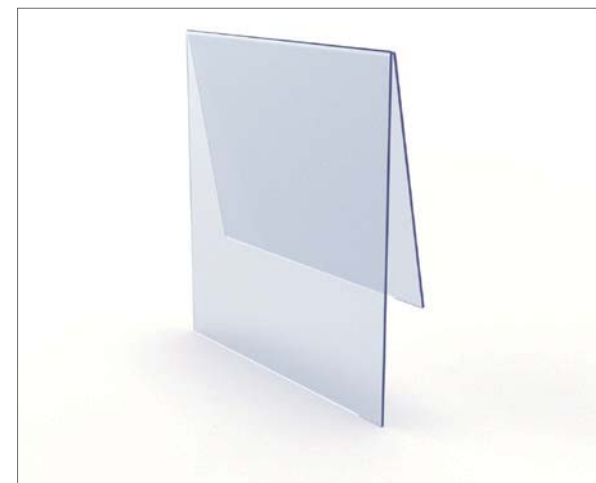

NEW



Ref.	Misure	Mat.		
10020107200	A7 (105 x 115 mm)	PVC	50	50 u

150 Tasche

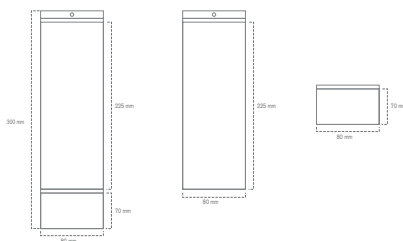
Display Multitasche Elettrosaldato



NEW

Ref.	Misure	Mat.		
10020105600	80 x 300 mm	PVC	50	1000 u
10020105800	80 x 225 mm	PVC	50	1000 u
10020105900	80 x 70 mm	PVC	50	1000 u









Porta messaggi da tavolo

154 Porta messaggi da tavolo

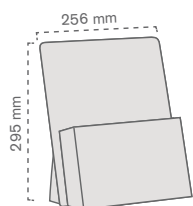

Porta volantini **A4**



Ref.	Misure	Mat.		
10040600500	A4	PETG	10	10 u

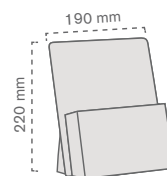

Porta volantini **A5**



Ref.	Misure	Mat.		
10040600600	A5	PETG	10	10 u

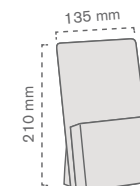

Porta volantini **1/3 di A4**



Ref.	Misure	Mat.		
10040600700	1/3 A4	PETG	10	10 u

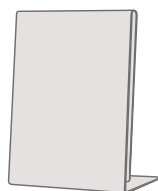
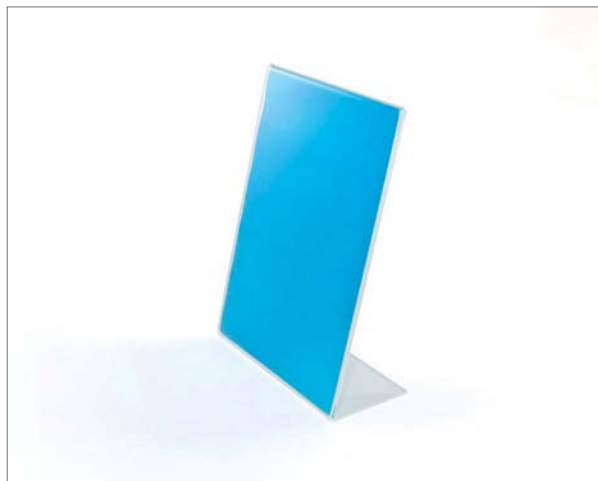

Porta messaggi **verticale** in **metacrilato**



Ref.	Misure	Mat.		
10020200100	A3	PMMA (2 mm)	5	5 u
10020200200	A4	PMMA (2 mm)	10	10 u
10020200300	A5	PMMA (2 mm)	10	10 u
10020200400	A6	PMMA (2 mm)	10	10 u
10020200500	A7	PMMA (2 mm)	10	10 u

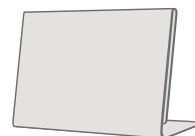

Porta messaggi **orizzontale** in **metacrilato**

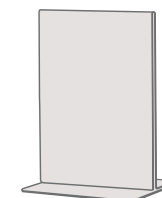

Ref.	Misure	Mat.		
10020200600	A3	PMMA (2 mm)	5	5 u
10020200700	A4	PMMA (2 mm)	10	10 u
10020200800	A5	PMMA (2 mm)	10	10 u
10020200900	A6	PMMA (2 mm)	10	10 u
10020201000	A7	PMMA (2 mm)	10	10 u

Porta messaggi **verticale** bifacciale in **metacrilato**



Ref.	Misure	Mat.		
10020201100	A3	PMMA (2 mm)	5	5 u
10020201200	A4	PMMA (2 mm)	10	10 u
10020201300	A5	PMMA (2 mm)	10	10 u
10020201400	A6	PMMA (2 mm)	10	10 u
10020201500	A7	PMMA (2 mm)	10	10 u

156 Porta messaggi da tavolo

Porta messaggi **orizzontale** bifacciale in **metacrilato**

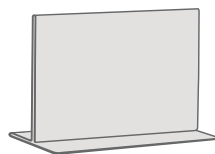

Ref.	Misure	Mat.		
10020201600	A3	PMMA (2 mm)	5	5 u
10020201700	A4	PMMA (2 mm)	10	10 u
10020201800	A5	PMMA (2 mm)	10	10 u
10020201900	A6	PMMA (2 mm)	10	10 u
10020202000	A7	PMMA (2 mm)	10	10 u

Porta messaggi **verticale** in **PETG/ PVC**

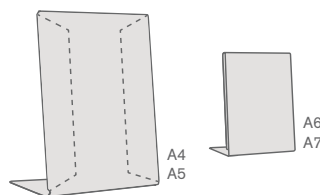

Ref.	Misure	Mat.		
10020202100	A4	PETG	50	50 u
10020202200	A5	PETG	25	25 u
10020202300	A6	PVC	75	75 u
10020202400	A7	PVC	125	125 u

Su ordinazione i modelli sono disponibili anche in PVC.

Porta messaggi **orizzontale** in **PETG/ PVC**

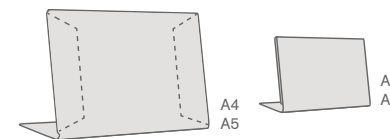
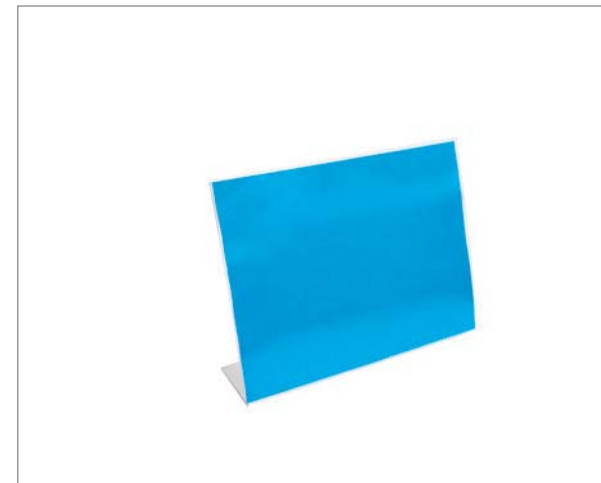



Ref.	Misure	Mat.		
10020202500	A4	PETG	50	50 u
10020202600	A5	PETG	25	25 u
10020202700	A6	PVC	75	75 u
10020202800	A7	PVC	150	150 u

Su ordinazione i modelli sono disponibili anche in PVC.

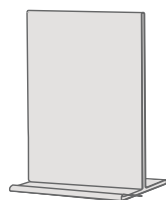

Porta messaggi **verticale** bifacciale in **PETG**

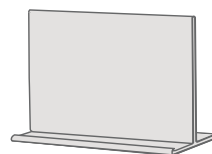

Ref.	Misure	Mat.		
10020202900	A4	PETG	25	25 u
10020203000	A5	PETG	50	50 u

Porta messaggi **orizzontale** bifacciale in **PETG**



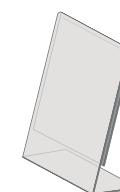
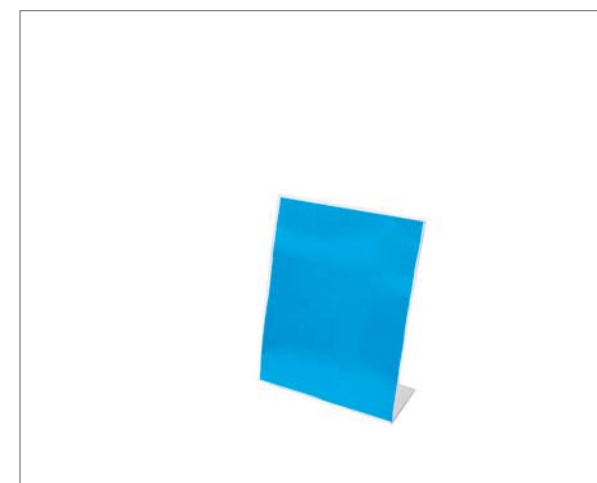

Ref.	Misure	Mat.		
10020203300	A4	PETG	25	25 u
10020203400	A5	PETG	50	50 u

Porta messaggi monofacciale **verticale**



NEW

Ref.	Misure	Mat.		
10020204100	A8	PVC	25	25 u





Telescopici e cornici

160 Telescopici e cornici

Telescopico con base metallica



Il kit si compone di base metallica, piede regolabile e testina in plastica iniettata per il fissaggio della cornice. Cornice non inclusa.

Ref.	Misure	Colore		
10020300100	De 300 a 600 mm	RAL 7040	10	10 u
10020300200	De 300 a 600 mm	RAL 3020	10	10 u
10020300300	De 300 a 600 mm	NERO	10	10 u

Cornice per telescopico

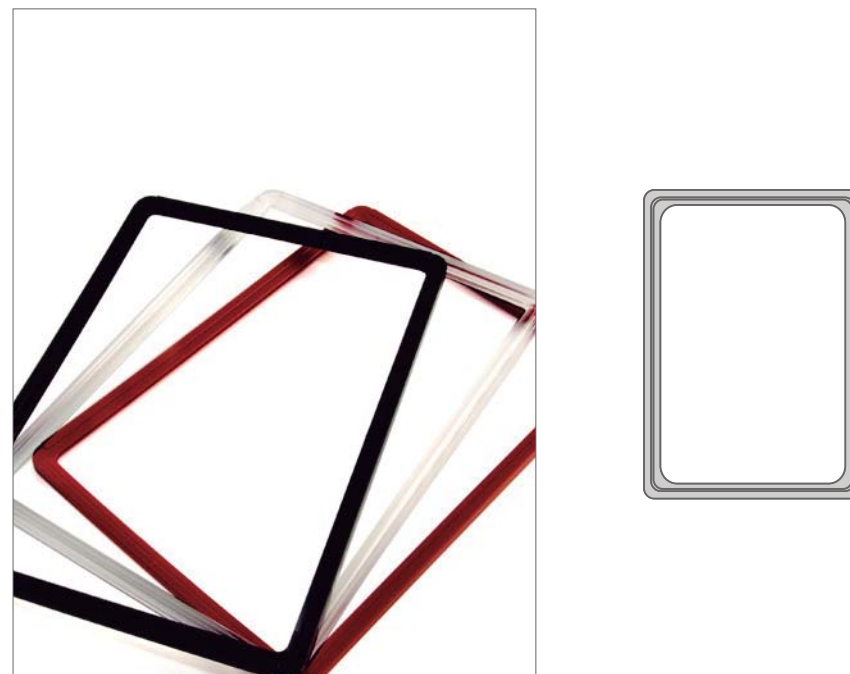

Cornice porta messaggi utile per comunicare qualsiasi tipo di offerta o caratteristiche di prodotto. Questo modello può essere abbinato ai telescopici per facilitarne il suo posizionamento nel punto vendita.

Misure	Misure/ Referenza				
	TTE	RAL 3020	NERO		
A3	10020300400	10020301200	10020300800	10	10 u
A4	10020300500	10020301300	10020300900	10	10 u
A5	10020300600	10020301400	10020301000	10	10 u
A6	10020300700	10020301500	10020301100	10	10 u

Accessori per cornici

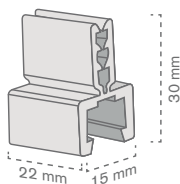

Ref.	Misure	Colore		
10020302000	15 x 22 x 30 mm	TTE	20	20 u

Suporto cartello per cornice

Pinza per cornice nello specifico disegnata per sostenere la cartellonistica.

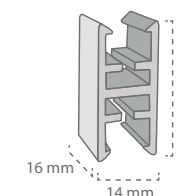

Ref.	Misure	Colore		
10020302200	14 x 16 x 30 mm	TTE	20	20 u

Connettore per cornici

Elemento che permette di unire due cornici allo stesso tempo.

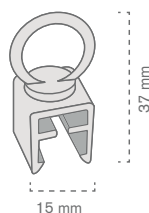

Ref.	Misure	Colore		
10020302100	15 x 15 x 37 mm	TTE	20	20 u

Anello per cornice

Anello ideato per funzionare come elemento di sospensione per cornice.

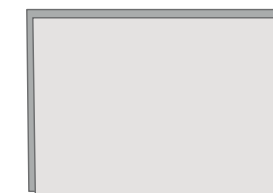
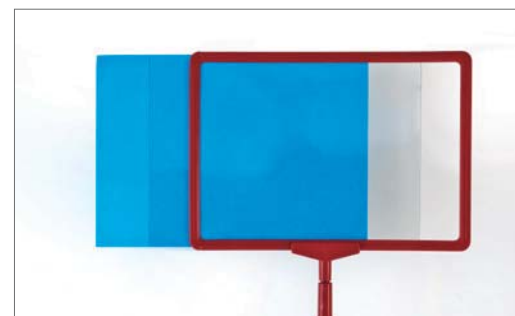

Ref.	Misure	Mat.		
10020301600	A3	PVC	10	10 u
10020301700	A4	PVC	10	10 u
10020301800	A5	PVC	10	10 u
10020301900	A6	PVC	10	10 u

Display per cornice

Display protettivo indicato per cornici.

162 | Telescopici e cornici

Accessori per cornice

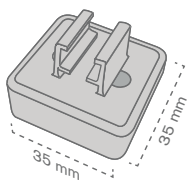

Ref.	Misure	Colore		
10050300500	35 x 35 mm	BIANCO	10	10 u

Supporto calamitato base.
Supporto calamitato per superfici metalliche. Ideale per sostenere cornici.

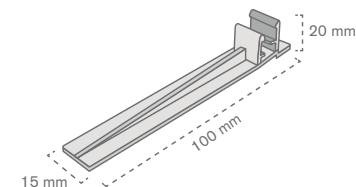

Ref.	Misure	Colore		
10020302300	15 x 100 x 20 mm	TTE	20	20 u

Base frontale per cornici
Base trasparente indicata specialmente per sostenere cornici su superfici piane.

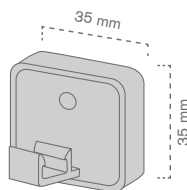

Ref.	Misure	Colore		
10050300600	35 x 35 mm	BIANCO	10	10 u

Supporto calamitato a parete.
Supporto calamitato per pareti metalliche. Ideale per sostenere cornici.

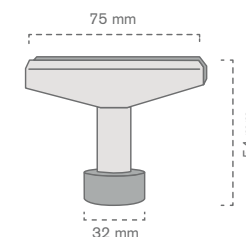

Ref.	Misure	Colore		
10050301000	75 x 32 x 54 mm	TTE	20	20 u

T con calamita per cornici.
Supporto calamitato a T disegnato per agganciare cornici.

Pinza porta cornici

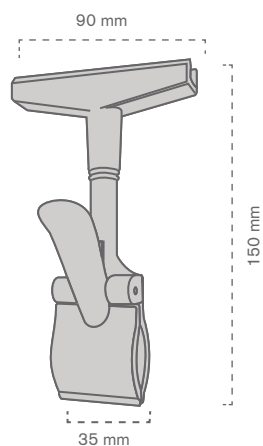

Pinza porta cornici disponibile in diversi colori. Questo modello è specialmente indicato per barre fino a 30 mm di diametro, permettendo la collocazione di una cornice nella parte superiore.

Ref.	Misure	Colore		
10050101100	90 x 150 mm	BIANCO	10	10 u
10050102400	90 x 150 mm	TTE	10	10 u
10050102300	90 x 150 mm	NERO	10	10 u

Pinza porta display

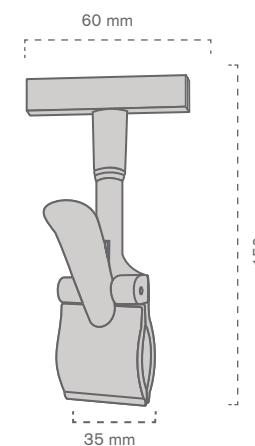

Pinza porta display disponibile in diversi colori. Questo modello di pinza è specialmente indicato per barre fino a 30 mm di diametro, permettendo la collocazione di un display nella parte superiore (misura massima A4).

Ref.	Misure	Colore		
10050102900	60 x 150 mm	BIANCO	10	10 u
10050102100	60 x 150 mm	TTE	10	10 u
10050102200	60 x 150 mm	NERO	10	10 u





Piede **A**mericano

166 | Piede Americano

Piede Americano **metallico**

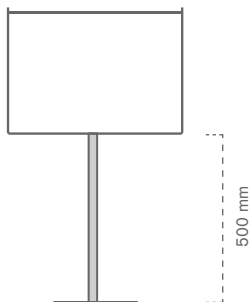

Ref.	Misure		Mat.	Colore		
	Altezza piede	Messaggio				
10020400100	500 mm	A3	Metallo	NERO	5	5 u

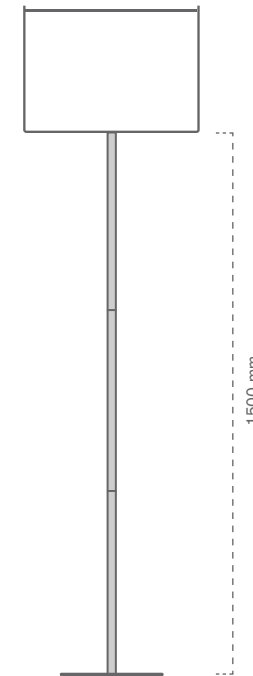

Ref.	Misure		Mat.	Colore		
	Altezza piede	Messaggio				
10020400200	1500 mm	A2	Metallo	NERO	5	5 u
10020400300	1500 mm	A3	Metallo	NERO	5	5 u

Piede Americano **metallico**

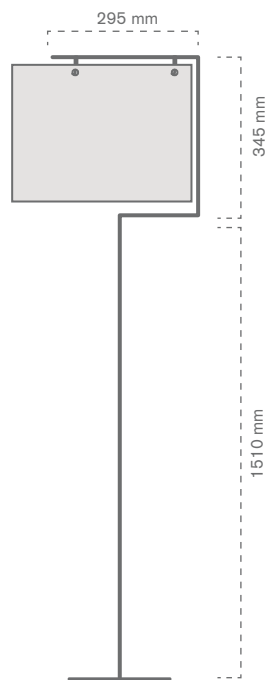

Ref.	Misure		Mat.	Colore	🛒	📄
	Altezza piede	Tasca				
10020400400	1510 mm	A3	Metallo	BIANCO	5	5 u

Display per Piede Americano

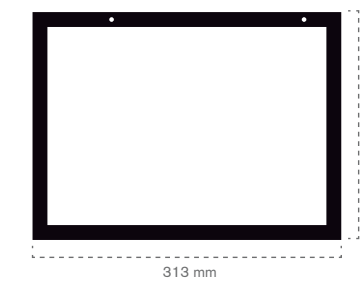
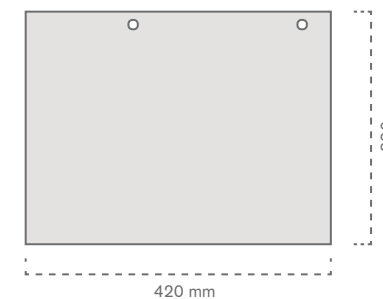

NEW

Ref.	Misure	Mat.	🛒	📄
10020407800	313 x 226 mm	PVC	5	5 u

168 | Piede Americano

Piede Americano **metallico** per display
“U” in metacrilato



NEW

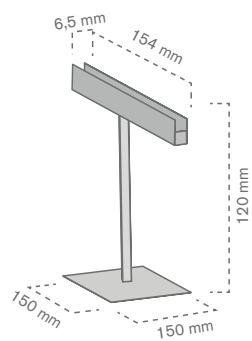

NEW

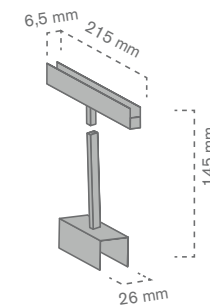

Ref.	Misure		Mat.	Colore	🛒	📄
	Altezza piede	Messaggio				
10020407400	120 mm	A5	Metallo	NERO	5	5 u
10020407500	120 mm	A5	Metallo	BIANCO	5	5 u

Ref.	Misure		Mat.	Colore	🛒	📄
	Altezza piede	Messaggio				
10020407600	145 mm	A4	Metallo	BIANCO	5	5 u
10020407700	145 mm	A4	Metallo	NERO	5	5 u

Piede Americano estensibile metallico per display "U" in metacrilato



NEW

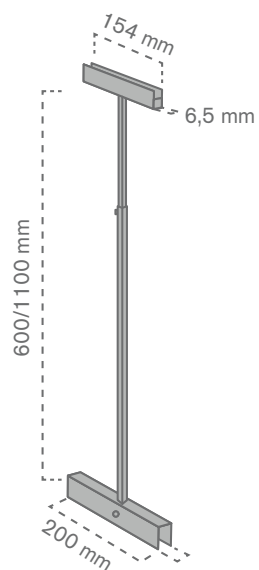

Ref.	Misure		Mat.	Colore		
	Altezza piede	Messaggio				
10020400700	600/1100 mm	A5	Metallo	BIANCO	5	5 u
10020407100	600/1100 mm	A5	Metallo	NERO	5	5 u



NEW

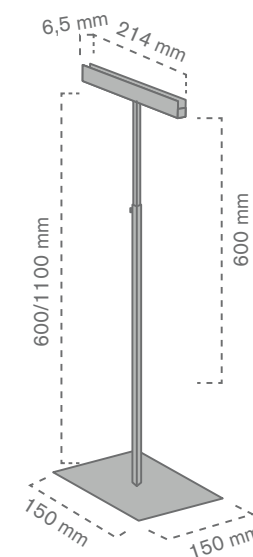

Ref.	Misure		Mat.	Colore		
	Altezza piede	Messaggio				
10020407200	600/1100 mm	A4	Metallo	BIANCO	5	5 u
10020407300	600/1100 mm	A4	Metallo	NERO	5	5 u





Porta messaggi IFCO

172 Porta messaggi IFCO

Porta messaggi IFCO

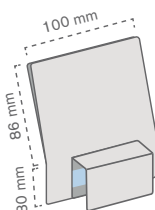

Ref.	Misure		Mat.	🛒	📄
	Pinza	Messaggio			
10020500100	30 mm	100 x 86 mm	PVC TTE	25	25 u

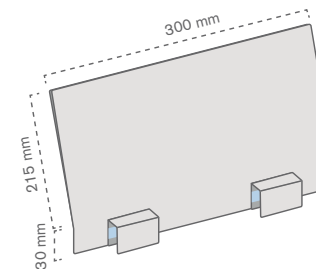

Ref.	Misure		Mat.	🛒	📄
	Pinza	Messaggio			
10020500300	30 mm	300 x 215 mm	PVC TTE	10	10 u

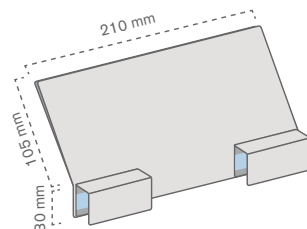

Ref.	Misure		Mat.	🛒	📄
	Pinza	Messaggio			
10020500200	30 mm	210 x 105 mm	PVC TTE	25	25 u





Base pato

176 Base pato

Base pato e componenti

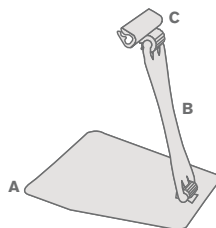

Ref.	Misure	Colore		
10020600100	Kit 200 mm	TTE	50	50 u
10020600200	Kit 100 mm	TTE	50	50 u

Kit pato TTE.
Base con supporto indicata per l'inserimento di displays. Il suo aggancio e la sua testina oscillante consentono di utilizzarlo in diverse posizioni.

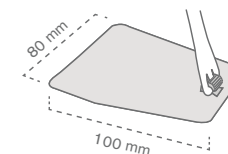

Ref.	Misure	Colore		
10020600500	80 x 100 mm	TTE	50	50 u

Base TTE.
Base trasparente per pato.

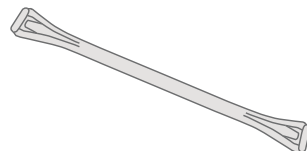

Ref.	Misure	Colore		
10020600300	Lunghezza 200 mm	TTE	50	50 u
10020600400	Lunghezza 100 mm	TTE	50	50 u

Braccetto TTE 100/200 mm.
Prolunga trasparente di diverse lunghezze. Questo articolo si utilizza combinato alla base pato.

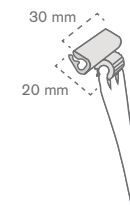

Ref.	Misure	Colore		
10020600600	30 x 20 mm	TTE	50	50 u

Testina oscillante TTE.
Testina oscillante per base pato. Questa testina consente di cambiare l'inclinazione del display.







Porta messaggi per reparti

180 Porta messaggi per reparti

Cavalletto porta cartelli per materassi

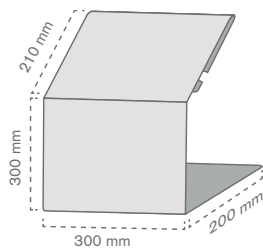

Ref.	Misure		Mat.	📏	📄
	Pinza	Messaggio			
10020800100	300 mm	A4	PMMA TTE (3 mm)	10	10 u

Tasca porta cartelli per materassi



Ref.	Misure		Mat.	📏	📄
	Generale	Messaggio			
10020800200	2300 x 460 mm	A4	PVC TTE	25	25 u
10020800300	1700 x 460 mm	A4	PVC TTE	25	25 u

Separatore di cassa in PVC espanso

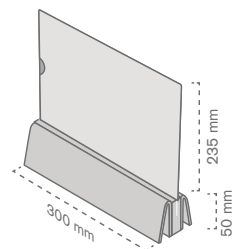

Ref.	Messaggio	Stampa	Colore*		
10020800400	A4	Non	1797 C	10	10 u

*Referenza di colore Pantone.

Separatore di cassa metallico

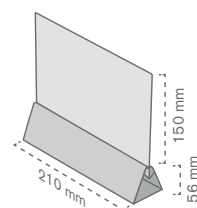
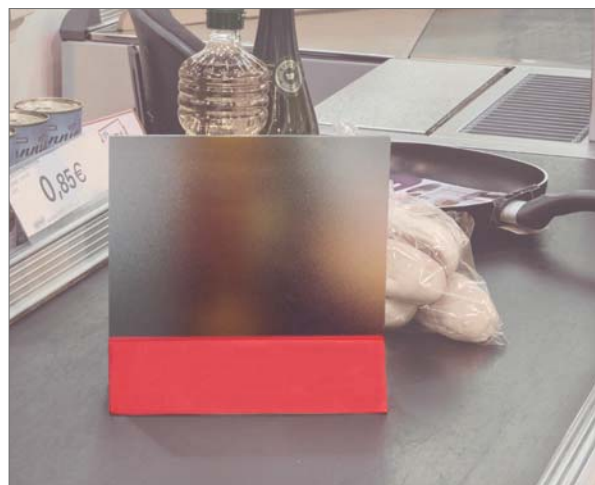

Ref.	Messaggio	Stampa	Colore		
10020800600	A5	Non	RAL 3020	10	10 u

Porta prezzo in PVC con 2 tasche

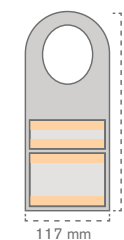

Ref.	Messaggio		Mat.		
	Superiore	Inferiore			
10020800800	105 x 40 mm	A7	PVC	25	1000 u*

*Ordine minimo per serigrafia. Per stampa digitale, l'ordine minimo é di 250 unt.

182 Porta messaggi per reparti

Supporto per pescheria con moquette

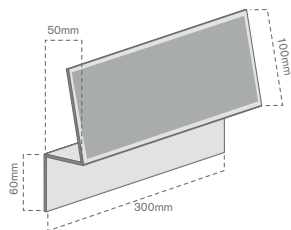

NEW

Ref.	Misure	Mat.		
10020802800	300 x 160 mm	PVC	8	8 u

Espositore rampa

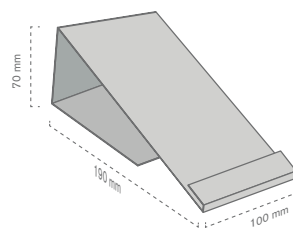

NEW

Ref.	Misure	Mat.		
10020802900	100 x 190 x 70 mm	PVC	10	10 u

Espositore lama per libri

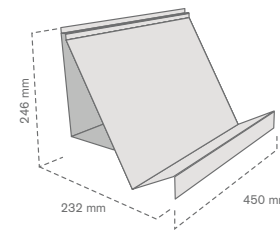
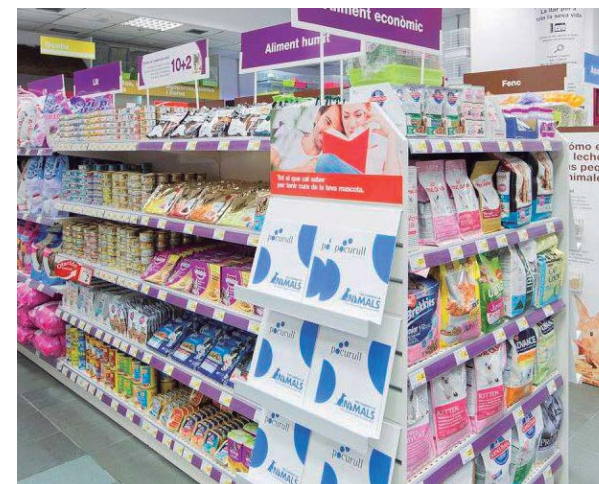

NEW

Ref.	Misure	Mat.		
10020803000	450 x 232 x 246 mm	Metal	5	5 u

Freezuz
Chips
1,46€
Freezuz
Meat & Chips
1,46€
Freezuz
CORDON BLEUE
sans gluten
Cooked by sam
1,85€
Freezuz
CORDON BLEUE
sans gluten
Cooked by sam
2,47€

FOOD
Freezuz
NUGGETS
5,30€
Freezuz
NUGGETS
4,90€
NEW PRODUCT
FAST
Tomatoes Pasty
5,30€
FAST
chicken NUGGETS
3,20€

READY MADE FOOD
READY MADE FOOD
READY MADE FOOD
READY MADE FOOD
READY MADE FOOD

HALF PRICE
HALF PRICE
Divella's
ITALIAN PIZZA
33% EXTRA FREE
1,20€
Quiche
2,69€
3,99€
2,89€

ALF
RICE
1/2
VEGE TABLETS
FISH
VEGE TABLETS



Comunicazione banchi frigo e surgelati

*Separatori
Evidenziatori di prezzo*







Separatori

188 Separatori

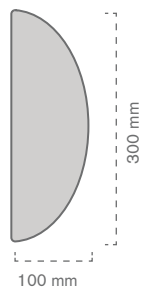
Separatore per **frigo verticale**



Separatore per frigo verticale disponibile in diversi materiali a seconda delle esigenze. Grafica e soggetti personalizzabili. Stampa digitale.

Ref.	Misure	Mat.		
10030100100	100 x 300 mm	PVC (500 my)	42	42 u
10030100200	100 x 300 mm	PVC Espanso (2 mm)	36	36 u

Separatore per **banchi frigo**

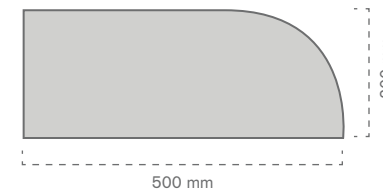

Separatore per banchi frigo personalizzabile a una o due facce. Si posiziona a banco grazie alle nostre pinze T trasparenti.

Ref.	Misure	Mat.		
10030100300	500 x 200 mm	PVC (500 my)	52	52 u

Separatore per banchi frigo

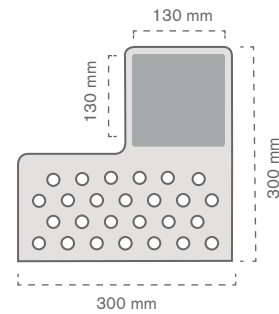

Separatore per banchi frigo, grafica e soggetti personalizzabili. Struttura forata per garantire la circolazione dell'aria fredda. Si posiziona a banco grazie alle nostre basette per separatori.

Ref.	Misure	Mat.		
10030100400	300 x 300 mm	PMMA TTE (3 mm)	36	36 u

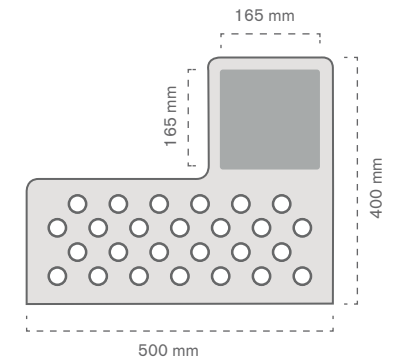

Separatore per banchi frigo. Si posiziona a banco grazie alle nostre basette per separatori. Struttura forata per garantire la circolazione dell'aria fredda. Personalizzabile in vari formati e grafiche.

Ref.	Misure	Mat.		
10030100500	500 x 400 mm	PMMA TTE (3 mm)	18	18 u

190 Separatori

Separatore per **banchi frigo**

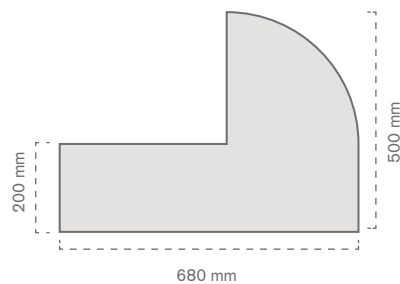

Separatore per banchi frigo, grafica e soggetti personalizzabili. Si posiziona a banco grazie alle nostre basette per separatori.

Ref.	Misure	Mat.		
10030100600	680 x 500 mm	PMMA TTE (3 mm)	8	8 u

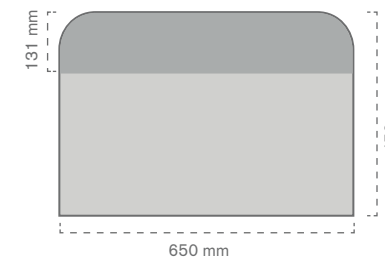

Separatore per banchi frigo. Si posiziona a banco utilizzando le nostre basette per separatori. Grafica e soggetti personalizzabili.

Ref.	Misure	Mat.		
10030100700	650 x 450 mm	PMMA TTE (3 mm)	9	9 u

Separatore per banchi frigo

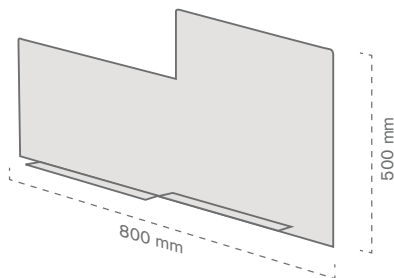

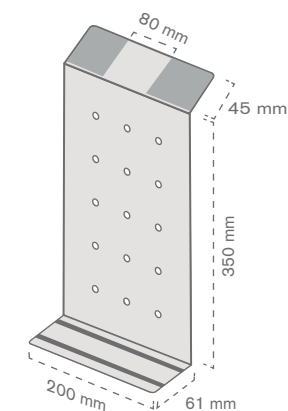

Separatore in metacrilato ad alta resistenza. Base dotata di doppia aletta per favorirne l'equilibrio. Personalizzabile in grafica e soggetti.

Ref.	Misure	Mat.		
				
10030100800	800 x 105 x 500 mm	PMMA TTE (5 mm)	10	10 u



Supporto calamitato flessibile. Include un porta prezzo inclinato nella parte superiore e due indicatori di prodotto.

Ref.	Misure		Mat.		
	Generale	Messaggio			
10030100900	200 x 61 x 382 mm	80 x 42 mm	Plastica	10	10 u

192 Separatori

Separatore per banchi frigo

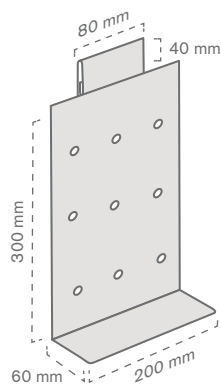

Supporto flessibile. Include un porta prezzo nella parte superiore.

Ref.	Misure		Mat.		
	Generale	Messaggio			
10030101000	200 x 60 x 340 mm	80 x 40 mm	Plastica	24	24 u

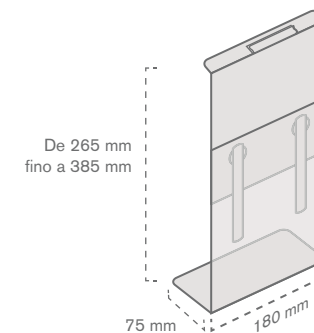

Supporto flessibile e **regolabile**. Altezza adattabile a seconda delle necessità espositive. Nella parte superiore può ospitare insieme prezzo e comunicazione.

Ref.	Misure	Mat.		

Separatore a scaletta

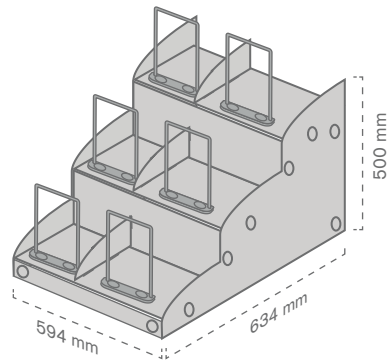

Separatore a forma di scaletta. Permette una migliore presentazione del prodotto. Particolarmente indicato per l'esposizione di pizze confezionate.

Ref.	Misure	Mat.	Colore		
10030101200	594 x 634 x 500 mm	PP Cellulare (5 mm)	NERO	1	1 u

Separatore per bancone

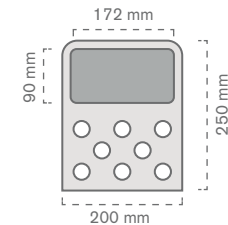
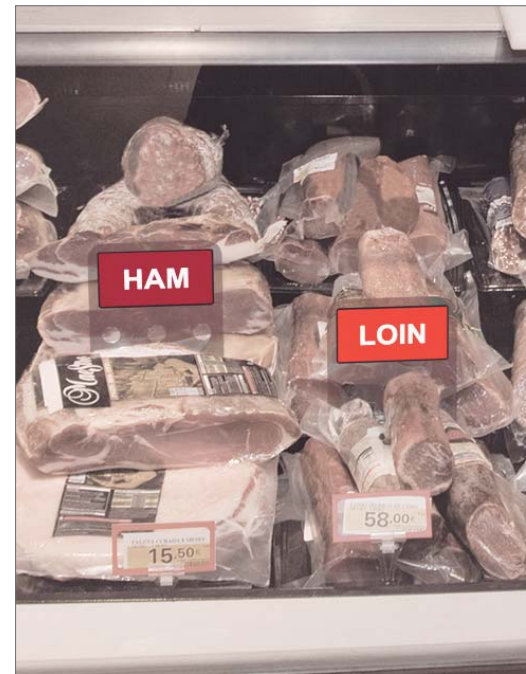

Separatore per bancone, grafica e soggetti personalizzabili a una o due facce. Si posiziona utilizzando le nostre basette trasparenti per separatori.

Ref.	Misure	Mat.		
10030101300	200 x 250 mm	PMMA TTE (3 mm)	30	30 u

194 Separatori

Separatore per **bancone**

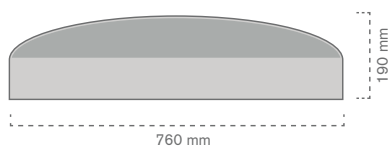



Separatore per bancone grafica e soggetti personalizzabili a una o due facce. Si posiziona utilizzando le nostre basette trasparenti per separatori.

Ref.	Misure	Mat.		
10030101400	760 x 190 mm	PMMA TTE (3 mm)	16	16 u

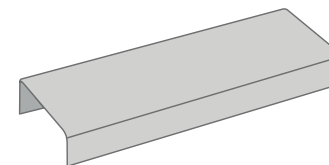
Falsa massa per **bancone**





Falsa massa in metacrilato per bancone pescheria. Grafica e soggetti personalizzabili.

Ref.	Misure	Mat.		
10030101500	200 x 950 x 70 mm	PMMA TTE (5mm)	8	8 u
10030101600	200 x 700 x 70 mm	PMMA TTE (5 mm)	12	12 u

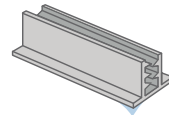
Accessori per separatori



Ref.	Misure	Mat.		
10050100500	76 x 13 mm	PVC TTE	100	100 u
10050100600	25 x 13 mm	PVC TTE	100	100 u

Pinza a T adesiva.
 Provvista di adesivo spugnoso, consente la sospensione di cartelli fino a 3 mm. di spessore. Larghezza personalizzabile.

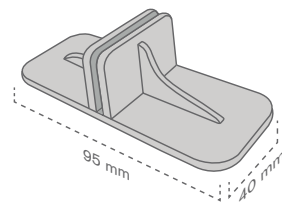

Ref.	Misure	Mat.		
10050100200	95 x 40 mm	PC TTE	25	25 u

Base TTE per separatori.
 Base particolarmente indicata per supportare articoli di 3 mm. di spessore.





Evidenziatori di prezzo

198 Evidenziatori di prezzo

Base pato e componenti

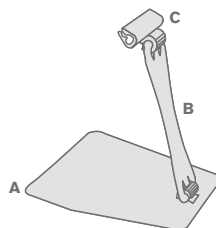

Ref.	Misure	Colore		
10020600100	Kit 200 mm	TTE	50	50 u
10020600200	Kit 100 mm	TTE	50	50 u

Kit pato TTE.
Base con supporto indicata per l'inserimento di displays. Il suo aggancio e la sua testina oscillante consentono di utilizzarlo in diverse posizioni.

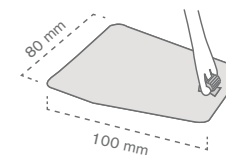

Ref.	Misure	Colore		
10020600500	80 x 100 mm	TTE	50	50 u

Base TTE.
Base trasparente per pato.

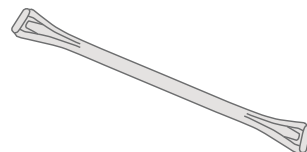

Ref.	Misure	Colore		
10020600300	Lunghezza 200 mm	TTE	50	50 u
10020600400	Lunghezza 100 mm	TTE	50	50 u

Braccetto TTE 100/200 mm.
Prolunga trasparente di diverse lunghezze. Questo articolo si utilizza combinato alla base pato.



Ref.	Misure	Colore		
10020600600	30 x 20 mm	TTE	50	50 u

Testina oscillante TTE.
Testina oscillante per base pato. Questa testina consente di cambiare l'inclinazione del display.

Porta prezzo a cassetto con cornice e rompighiaccio

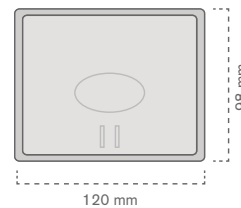

Ref.	Misure	Colore		
10030200100	120 x 98 mm	BLU	20	20 u

Porta prezzo a cassetto.
Cassetto ermetico indicato per reparti alimentari freschi.

Complementi per porta prezzo a cassetto

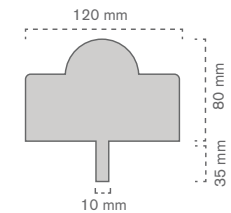

Ref.	Messaggio	Mat.		
10030200300	120 x 80 mm	PVC	25	1000 u*

Evidenziatore per cassetto.
Evidenziatore personalizzabile per porta prezzo a cassetto. Ideale per comunicare offerte.

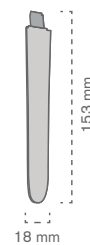

Ref.	Misure	Colore		
10030200200	18 x 153 mm	BIANCO	20	20 u

Rompighiaccio per cassetto.
Braccetto per porta prezzo a cassetto. La sua punta è studiata per facilitarne l'inserimento nel ghiaccio.

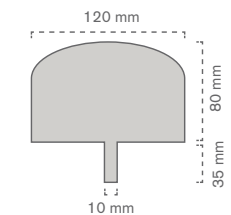

Ref.	Messaggio	Mat.		
10030200400	120 x 80 mm	PVC	25	1000 u*

Evidenziatore semicircolare.
Evidenziatore semicircolare progettato per porta prezzo a cassetto con cornice.

200 Evidenziatori di prezzo

Rompighiaccio personalizzabile

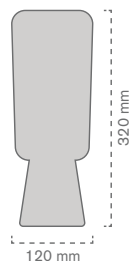

Ref.	Misure	Mat.		
10030200500	120 x 320 mm	PVC Espanso (2 mm)	35	70 u

Rompighiaccio stampato.
 Studiato per evidenziare offerte del banco pescheria. La sua base ne facilita l'inserimento nel ghiaccio.

Supporto display pescheria

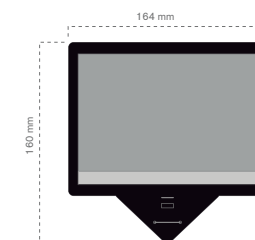

Ref.	Misure	Mat.		
10030200700	164 x 160 mm	PP (3 mm)	50	50 u

Supporto display A6 pescheria.
 Include un display A6 frontalmente ed un display A7 nella parte posteriore



purity

PERSONAL CARE PRODUCTS

50% OFF
on 2nd item

purity

PERSONAL CARE PRODUCTS

Special Offer

BAKERY

Special Offer

purity
PERSONAL CARE PRODUCTS

50% OFF
on 2nd item
purity
PERSONAL CARE PRODUCTS

50% OFF
on 2nd item
purity
PERSONAL CARE PRODUCTS

50% OFF
on 2nd item
purity
PERSONAL CARE PRODUCTS

PERSONAL CARE PRODUCTS

UTCHI

New
26.99

New
1875 watt
F SERIES
Ionic ceramic technology
Rowenti

New
F SERIES
Rowenti
New
SERIES
Rowenti
New

purity
PERSONAL CARE PRODUCTS

purity
PERSONAL CARE PRODUCTS

purity
PERSONAL CARE PRODUCTS

shower gel
silk glow
1.25€

50% OFF
on 2nd item
purity
PERSONAL CARE PRODUCTS

50% OFF
on 2nd item
purity
PERSONAL CARE PRODUCTS

50% OFF
on 2nd item
purity
PERSONAL CARE PRODUCTS

PERSONAL CARE ZONE
purity
PERSONAL CARE ZONE

PERSONAL CARE ZONE
purity
PERSONAL CARE ZONE

PERSONAL CARE ZONE
purity
PERSONAL CARE ZONE

PERSONAL CARE ZONE
purity
PERSONAL CARE ZONE

Soluzioni per esposizione

*Isole CUBEplex®
Rivestimenti isola
Flexidecor® Series
Espositori di prodotto
Espositori porta volantini
Totem
Leggii
Coperture antitaccheggio
Box porta messaggi*





Cube[®]
plex



“ CUBEplex[®], la soluzione più pratica ed efficace per realizzare isole espositive.
Libera la tua fantasia ”

Il punto vendita insegue quotidianamente obiettivi sfidanti, ottimizzare gli spazi, renderli dinamici, stare attenti ai costi e, al tempo stesso generare esperienze d'acquisto uniche per il cliente, non è sempre facile. CUBEplex® è la nostra risposta. Sinonimo di polivalenza: CUBEplex® trasforma spazi vuoti in veri e propri spazi vendita. Può fare sia da sostituto sia da complemento per strutture fisse integrandosi alla perfezione con qualsiasi tipo di comunicazione e strategia di visual merchandising.

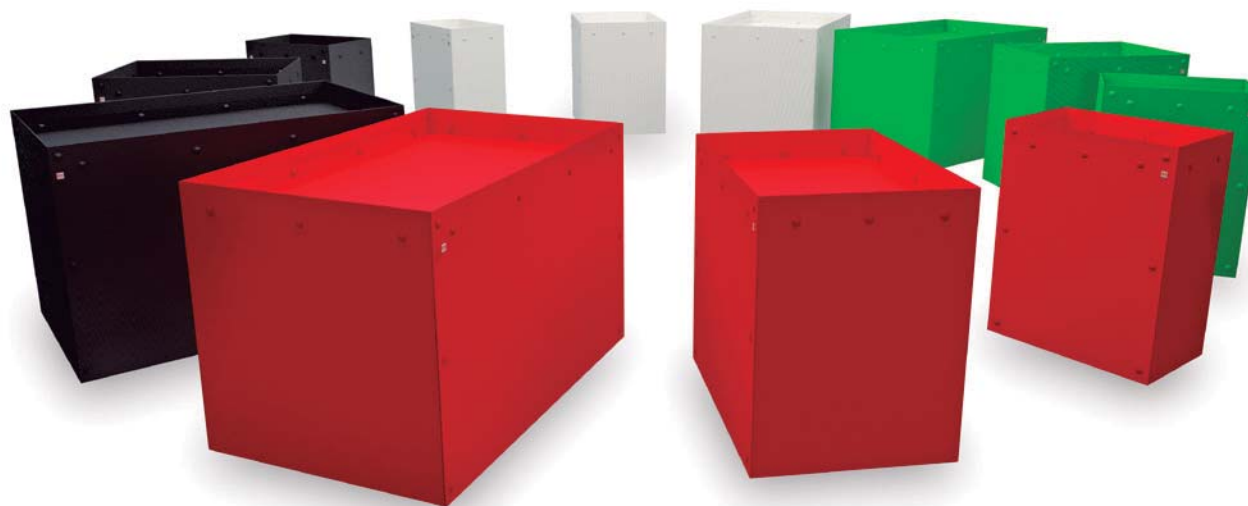

Applicazioni



Campagne lancio e stagionali o permanenti



Promozione di un marchio o di una famiglia di prodotti



Supporto visivo cross selling



Presentazione e esposizione



Tipicità regionali

La sua struttura offre ottime soluzioni funzionali al punto vendita. La sua impermeabilità lo rende resistente al contatto con sostanze liquide è facile da pulire, inoltre resiste agli impatti con carrelli e macchinari.



Vasto assortimento di **accessori** per aumentare l'efficacia delle campagne.



100% Personalizzabile Conferisce uniformità estetica alle isole espositive.

Riduce gli investimenti e i costi

indiretti delle strutture espositive.



Molto resistente

supporta fino a 200 kg. (modello L) di peso distribuito.

Montaggio facile e rapido in soli 6 passi.

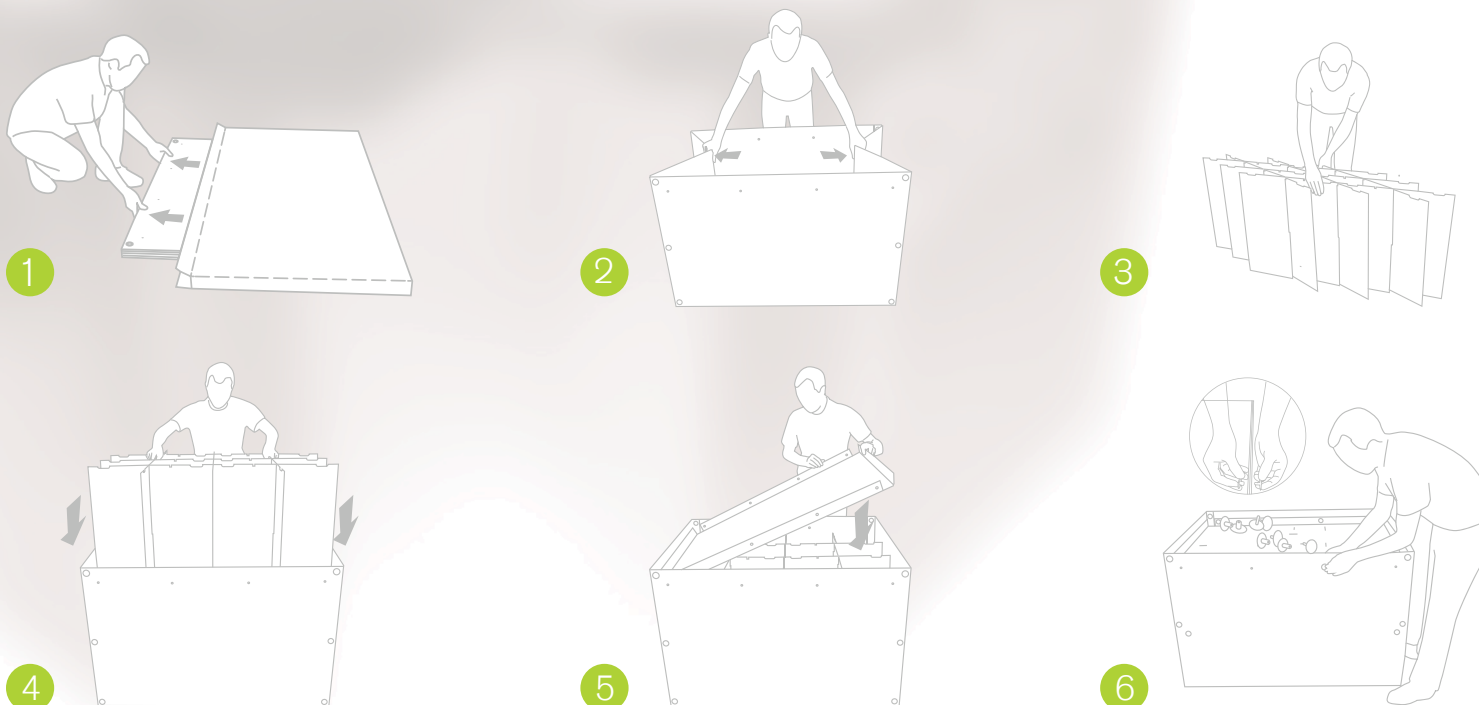

210 Isole CUBEplex®

CUBEplex® Basic

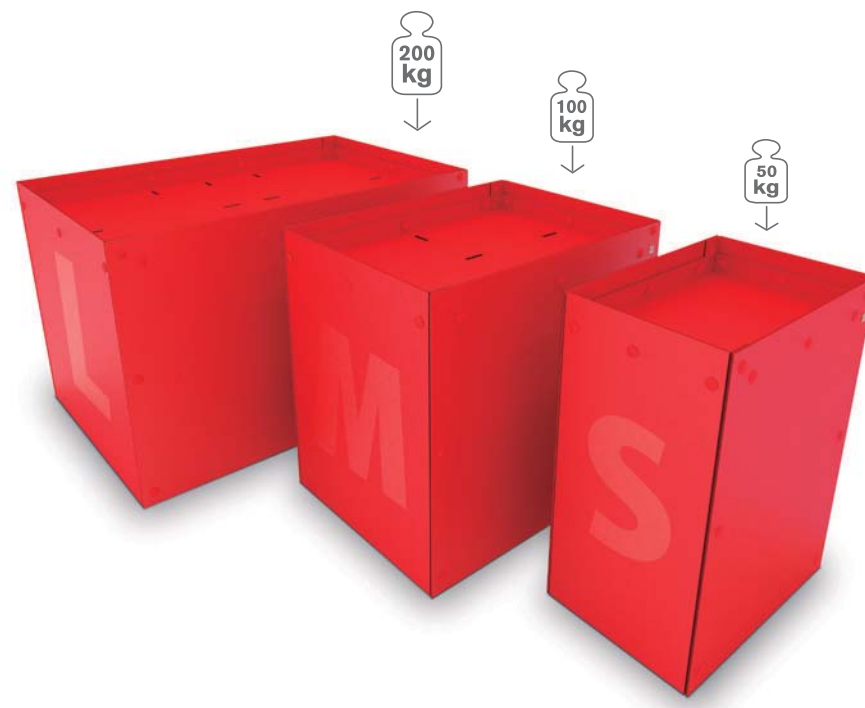

La famiglia **CUBEplex® Basic** si compone di 3 modelli di differente formato, classificati in L, M e S. Tutti compatibili con misure euro-pallet. Questi modelli a loro volta sono disponibili in 4 diversi colori.

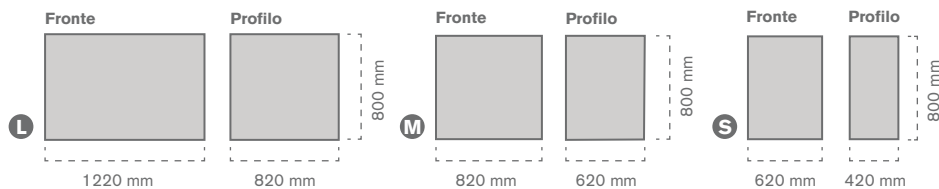

Mod.	Colore* / Referenza				Mat.		
	186 C	347 C	BIANCO	NERO			
L	10040100100	10040100200	10040100300	10040100400	PP Cellulare (5 mm)	1	1 u
M	10040100500	10040100600	10040100700	10040100800	PP Cellulare (5 mm)	1	1 u
S	10040100900	10040101000	10040101100	10040101200	PP Cellulare (5 mm)	1	1 u

CUBEplex® Triangle

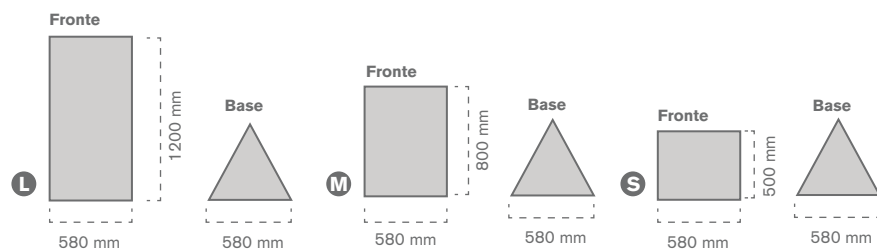

Più versatile e polivalente, il modello **Triangle**, grazie alla sua struttura triangolare e ai suoi vari formati permette di dar forma a infinite soluzioni espositive.

Mod.	Colore*/ Referenza				Mat.	🛒	📄
	186 C	347 C	BIANCO	NERO			
L	10040101300	10040101400	10040101500	10040101600	PP Cellulare (5 mm)	1	1 u
M	10040101700	10040101800	10040101900	10040102000	PP Cellulare (5 mm)	1	1 u
S	10040102100	10040102200	10040102300	10040102400	PP Cellulare (5 mm)	1	1 u

*Referenza di colore Pantone.

212 Isole CUBEplex®

Stepper 01

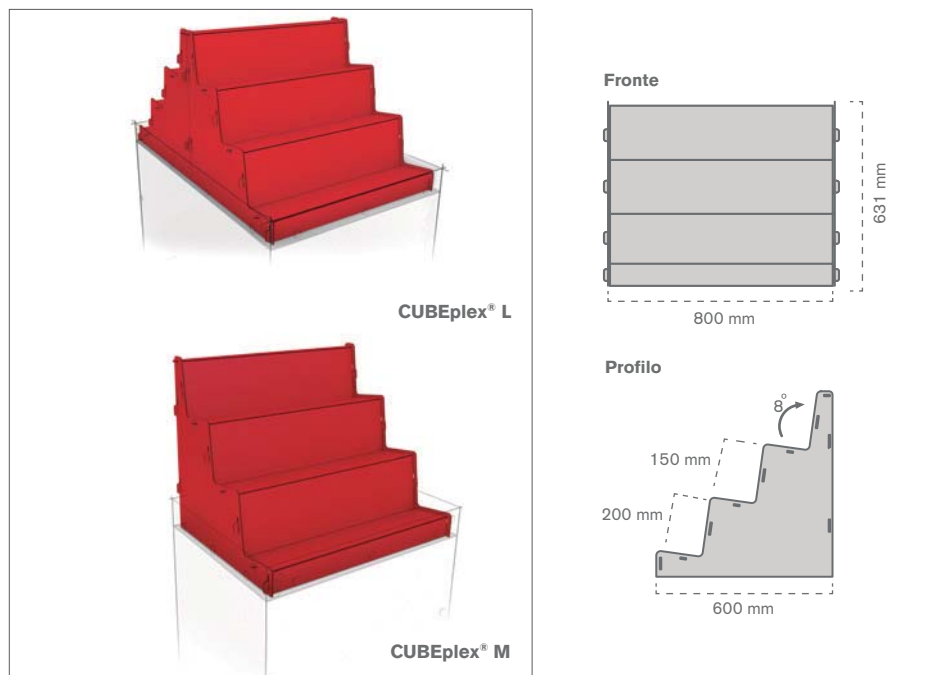

Scaletta inclinata a 3 ripiani per **CUBEplex® M**, può essere utilizzata in coppia per **CUBEplex® L**. L'inclinatura garantisce la stabilità dei prodotti esposti. È possibile applicargli profili porta prezzo.

Mod.	Colore* / Referenza				Mat.	🛒	📄
	186 C	347 C	BIANCO	NERO			
L	10040102500	10040102600	10040102700	10040102800	PP Cellulare (5 mm)	1	1 u
M	10040102900	10040103000	10040103100	10040103200	PP Cellulare (5 mm)	1	1 u

Stepper 02

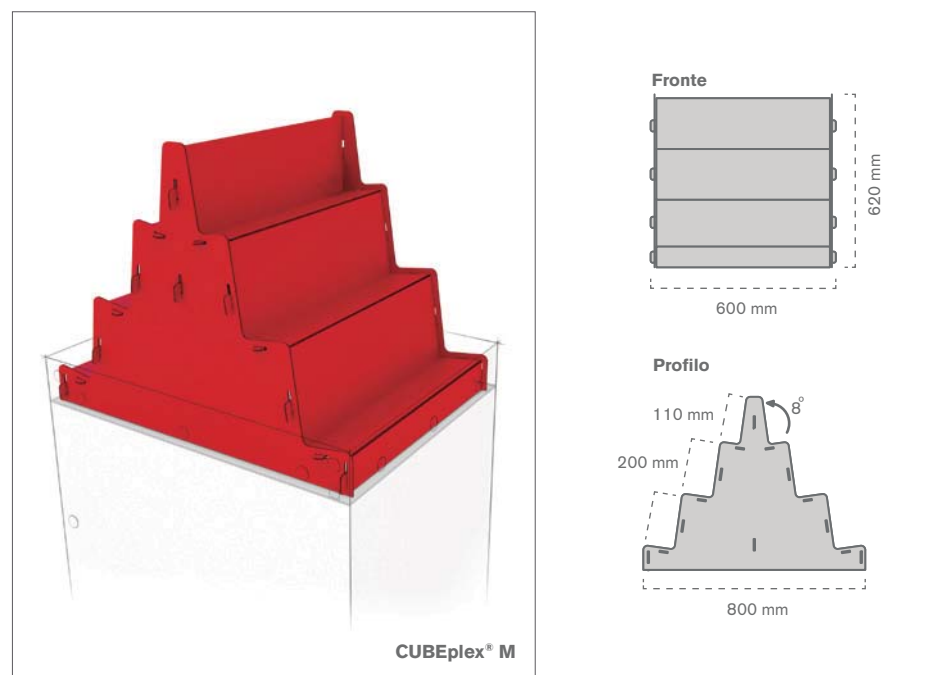

Scaletta piramidale a 3 + 3 gradini per **CUBEplex® M**. L'inclinatura garantisce la stabilità dei prodotti esposti. È possibile applicargli profili porta prezzo.

Mod.	Colore* / Referenza				Mat.	🛒	📄
	186 C	347 C	BIANCO	NERO			
M	10040102900	10040103000	10040103100	10040103200	PP Cellulare (5 mm)	1	1 u

Stepper 03

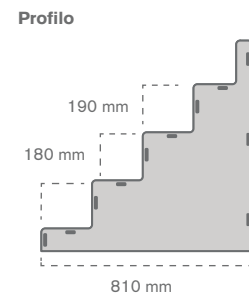
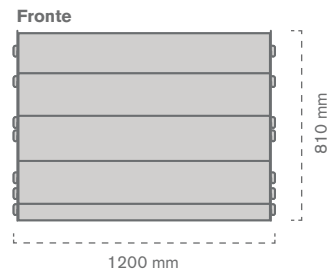

CUBEplex® L

Scaletta inclinata a 4 ripiani per CUBEplex® L. L'inclinatura garantisce la stabilità dei prodotti esposti. È possibile applicargli profili porta prezzo.

Mod.	Colore*/ Referenza				Mat.	Icona 1	Icona 2
	186 C	347 C	BIANCO	NERO			
L	10040103300	10040103400	10040103500	10040103600	PP Cellulare (5 mm)	1	1 u

Stepper 04

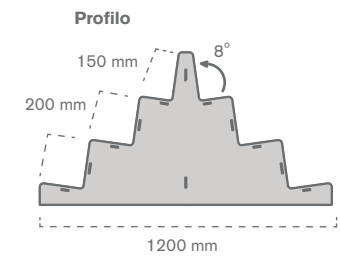
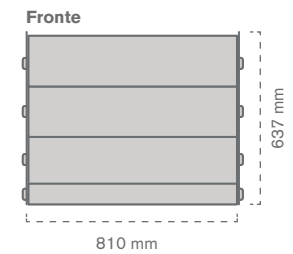

CUBEplex® L

Scaletta piramidale a 3 + 3 gradini per CUBEplex® L. L'inclinatura garantisce la stabilità dei prodotti esposti. È possibile applicargli profili porta prezzo.

Mod.	Colore*/ Referenza				Mat.	Icona 1	Icona 2
	186 C	347 C	BIANCO	NERO			
L	10040103700	10040103800	10040103900	10040104000	PP Cellulare (5 mm)	1	1 u

*Referenza di colore Pantone.

214 Isole CUBEplex®

Stepper 05

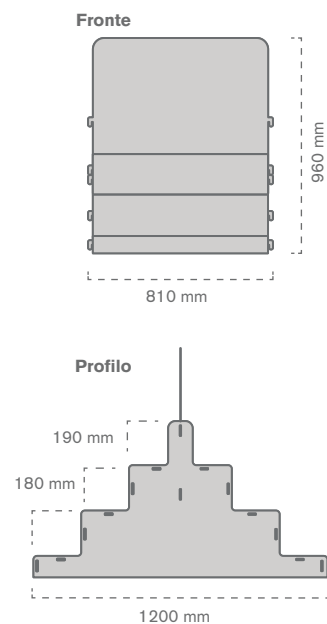
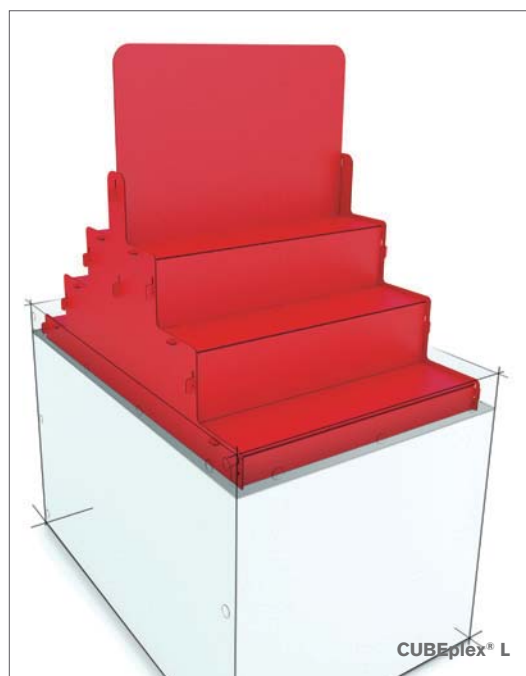

Scaletta piramidale a 3 + 3 gradini con spazio comunicazione per **CUBEplex® L**. Ideale per l'esposizione di prodotti a base piana. È possibile applicargli tasche porta messaggi e profili porta prezzo.

Mod.	Colore*/ Referenza				Mat.	Icona 1	Icona 2
	186 C	347 C	BIANCO	NERO			
L	10040104100	10040104200	10040104300	10040104400	PP Cellulare (5 mm)	1	1 u

Stepper 06

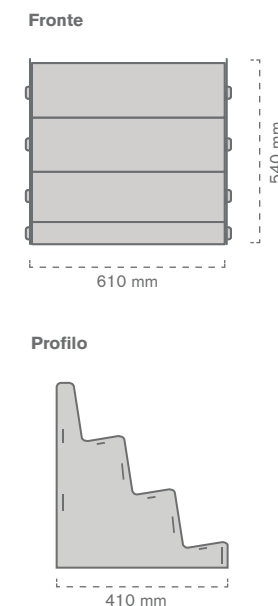

Scaletta inclinata a 3 ripiani per **CUBEplex® S**. L'inclinatura garantisce la stabilità dei prodotti esposti. È possibile applicargli profili porta prezzo.

Mod.	Colore*/ Referenza				Mat.	Icona 1	Icona 2
	186 C	347 C	BIANCO	NERO			
S	10040104500	10040104600	10040104700	10040104800	PP Cellulare (5 mm)	1	1 u

Podio L e M

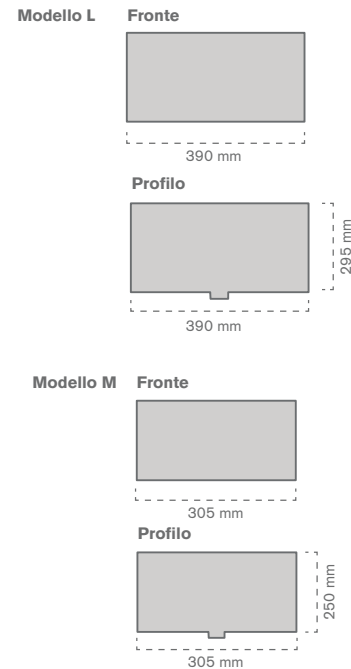
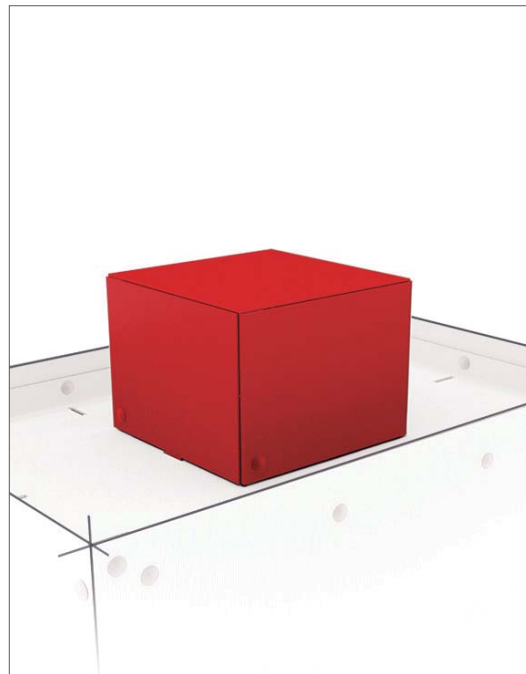

Podio per esposizione prodotti, disponibile in formato **L e M**. Valorizza e migliora la visibilità del prodotto.

Mod.	Colore*/ Referenza				Mat.	🛒	📄
	186 C	347 C	BIANCO	NERO			
L	10040105300	10040105400	10040105500	10040105600	PP Cellulare (5 mm)	1	1 u
M	10040104900	10040105000	10040105100	10040105200	PP Cellulare (5 mm)	1	1 u

Show Panel

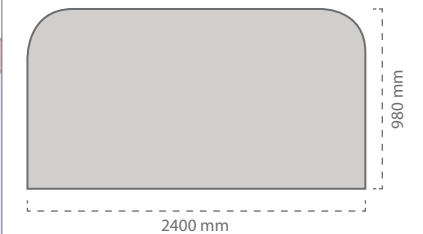
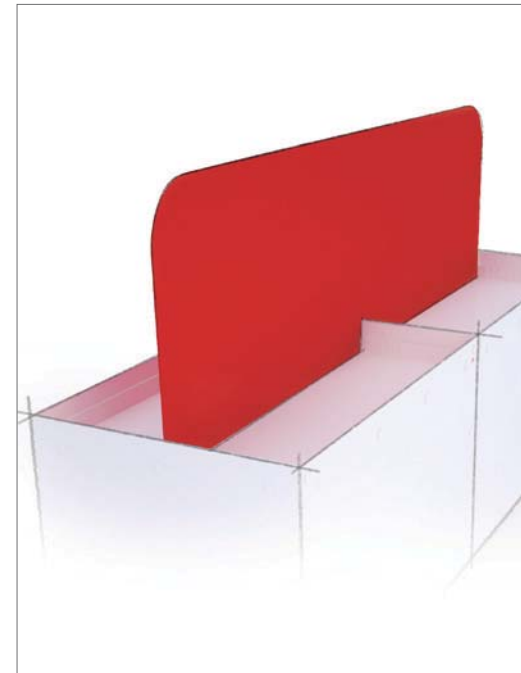

Show panel per **CUBEplex®**. Utilizzabile al tempo stesso come separatore di prodotti e come spazio per comunicazioni.

Mod.	Colore*/ Referenza				Mat.	🛒	📄
	186 C	347 C	BIANCO	NERO			
	10040105700	10040105800	10040105900	10040106000	PP Cellulare (5 mm)	1	1 u

*Referenza di colore Pantone.

216 Isole CUBEplex®

Kit separatore 4/6 spazi L

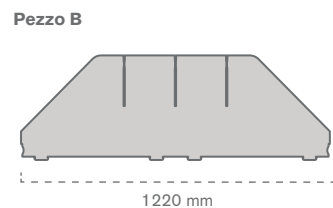
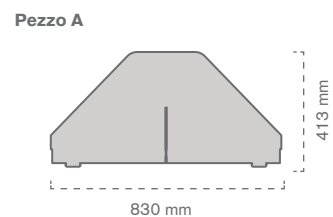
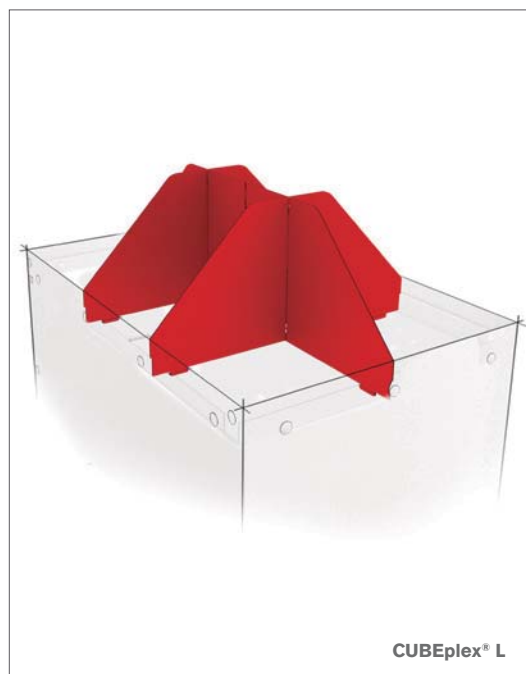

CUBEplex® L

Utile per suddividere in 4/6 spazi espositivi la superficie piana dei **CUBEplex® L**. Modello composto di due pezzi A e un pezzo B.

Mod.	Colore*/ Referenza				Mat.	Icona 1	Icona 2
	186 C	347 C	BIANCO	NERO			
L	10040106100	10040106200	10040106300	10040106400	PP Cellulare (5 mm)	1	1 u

Kit separatore 4 spazi M

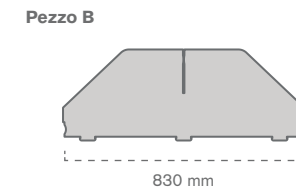
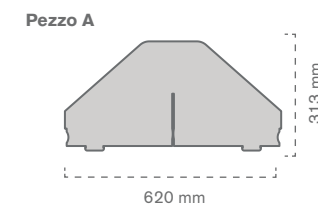
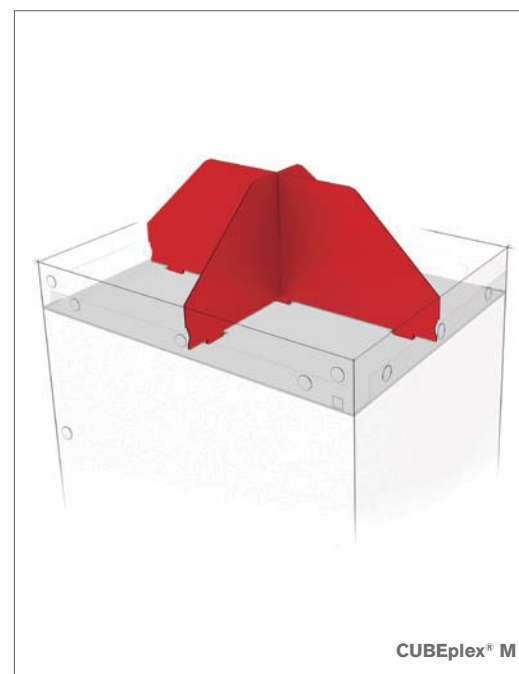

CUBEplex® M

Utile per suddividere in 4 spazi espositivi la superficie piana dei **CUBEplex® M**. Modello composto di un pezzo A e un pezzo B.

Mod.	Colore*/ Referenza				Mat.	Icona 1	Icona 2
	186 C	347 C	BIANCO	NERO			
M	10040106500	10040106600	10040106700	10040106800	PP Cellulare (5 mm)	1	1 u

Espositore a ganci

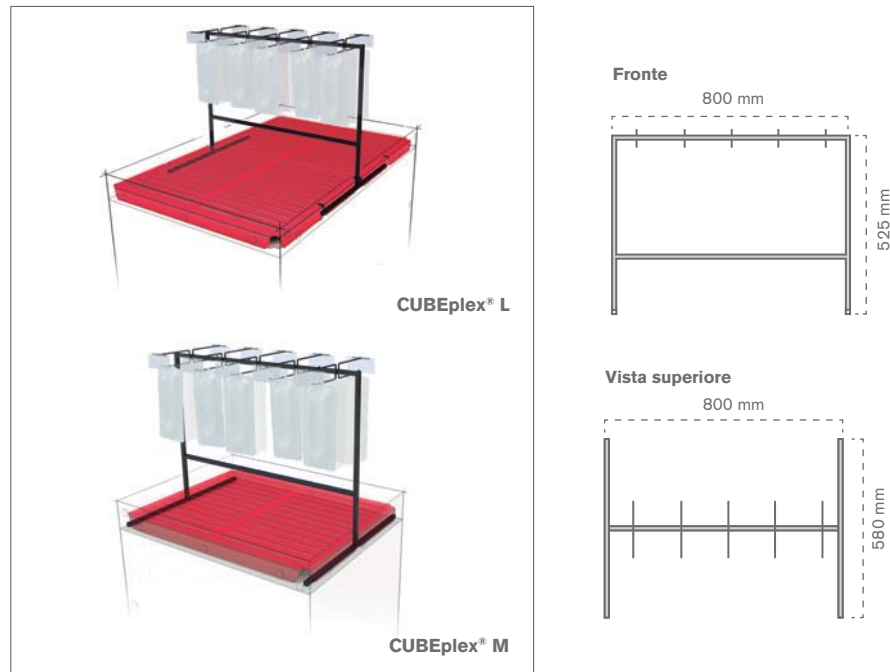

Espositore a ganci in metallo. Rende più accattivante e ordinata l'esposizione del prodotto. Modello per **CUBEplex® L e M**.

Mod.	Ref.	Mat.	Colore		
L M	10040106900	Metallo	NERO	1	1 u

Corner promozionale

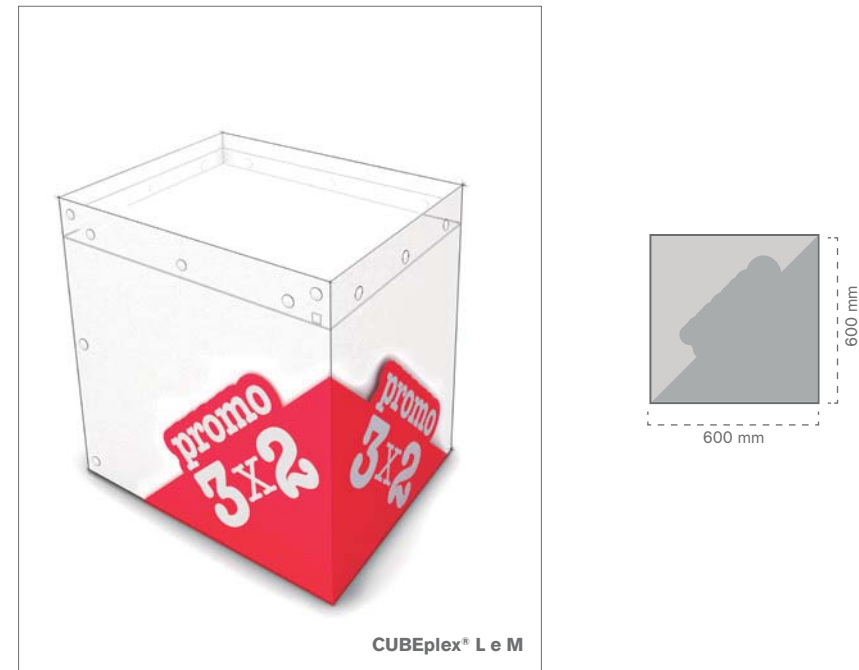

Studiato per dare dinamicità alla comunicazione, permette di orientare il messaggio su due angolazioni. Stampa e forma personalizzabili. Modello per **CUBEplex® L e M**.

Mod.	Colore*/ Referenza				Mat.		
	186 C	347 C	BIANCO	NERO			
L M	10040107000	10040107100	10040107200	10040107300	PP Cellulare	1	1 u

Unione moduli con velcro.

*Referenza di colore Pantone.

218 Isole CUBEplex®

Porta bottiglie per CUBEplex® Triangle

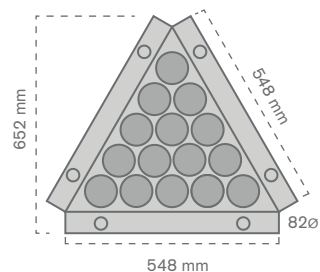
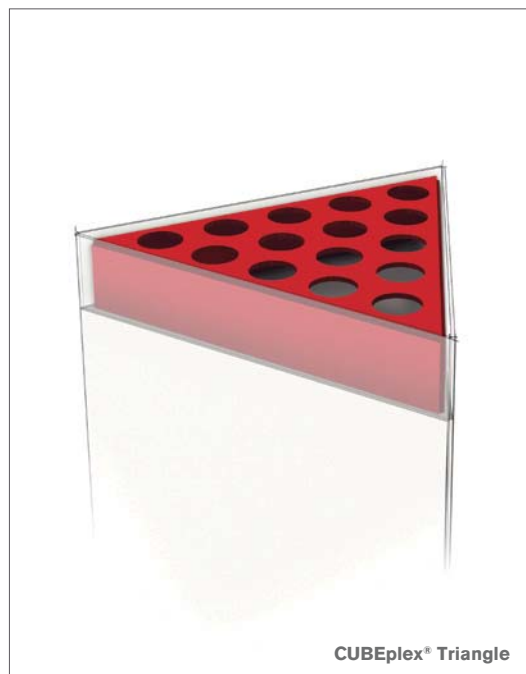

CUBEplex® Triangle

Armonizza l'esposizione del prodotto e ne favorisce la stabilità. Permette di esporre fino a 15 bottiglie.

Mod.	Colore*/ Referenza				Mat.	📄	📅
	186 C	347 C	BIANCO	NERO			
L M S	10040107400	10040107500	10040107600	10040107700	PP Cellulare (5 mm)	1	1 u

Pannello per CUBEplex® Triangle

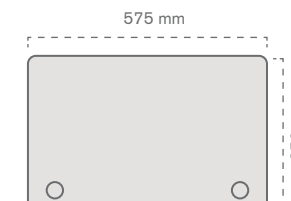

CUBEplex® Triangle



Permette di aumentare il carico, valorizza e dà visibilità al prodotto. Per tutti i modelli di CUBEplex® Triangle.

Mod.	Referenza	Misure	Mat.	📄	📅

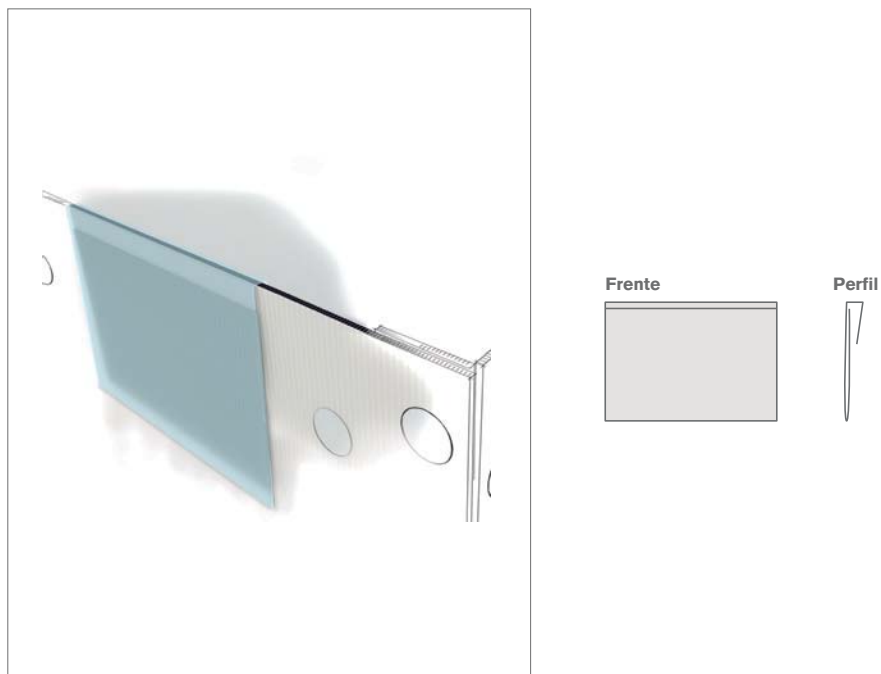
Display e protezione bordo





Tasca progettata per adattarsi perfettamente a tutti i modelli CUBEplex®.

Ref.	Misure	Mat.		
10040107900	A3	PVC	10	10 u
10040108000	A4	PVC	25	25 u
10040108100	A5	PVC	50	50 u

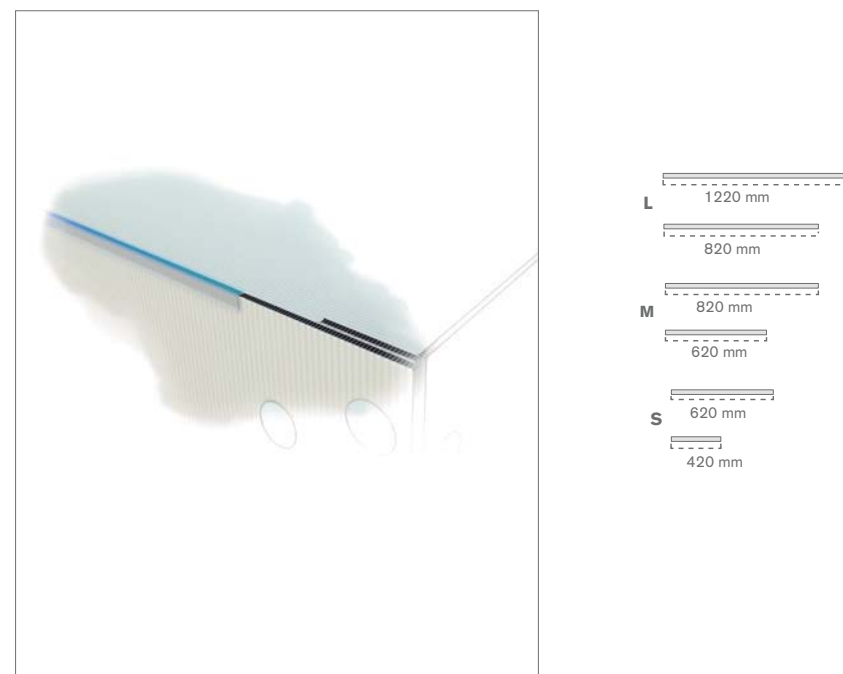
Protezione bordo



Protezione perfettamente a tutti i modelli CUBEplex®.

Mod.	Ref.	Misure	Mat.		
L	10040108200	1220/820	PVC TTE	10	10 u
M	10040108300	820/620	PVC TTE	10	10 u
S	10040108400	620/420	PVC TTE	10	10 u

Bottoni

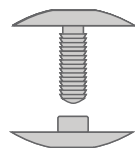

Misure	Colore*/ Referenza					
28 x 12,5 mm	186 C	347 C	TTE	NERO	100	100 u

*Referenza di colore Pantone.

Protezione angolo.

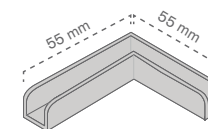



Protezione angolo: protezione trasparente adatta a tutti i modelli CUBEplex®.

Mod.	Ref.	Misure	Colore		
Destra	10040109700	55 x 55 mm	TTE	10	10 u
Sinistra	10040109800	55 x 55 mm	TTE	10	10 u

Kit di Comunicazione



kit Comunicazione per Cubeplex® - Composto da 3 profili porta cartello e protettore in PVC. Disponibile per tutti i modelli.

Ref.	Modello	Colore		
10040110800	L	TTE	1	1 u
10040110900	L	NERO	1	1 u
10040111000	M	TTE	1	1 u
10040111100	M	NERO	1	1 u
10040111200	S	TTE	1	1 u
10040111300	S	NERO	1	1 u

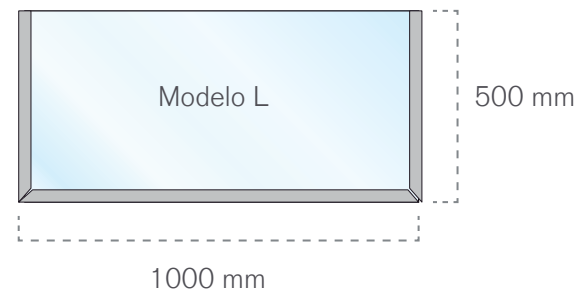
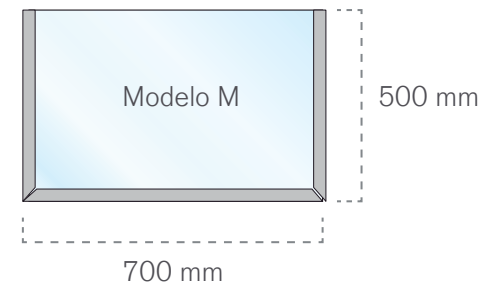
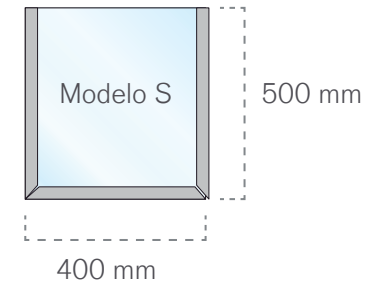



PATENTED SYSTEM

“Durante le nostre campagne **CUBEplex®** diventa sinonimo di risparmio e velocità di installazione; uniformità e pulizia di immagine, facilità di spostamento smontaggio e archiviazione”.

Dpto. Pubblicità e Merchandising Eroski





“È un supporto che porta aria di novità nel punto vendita; è resistente e soprattutto polivalente nell’utilizzo”.

Dpto. Pubblicità Uvesco Unialco





Rivestimenti isola

226 Rivestimenti isola

Sistema copri isola modulare

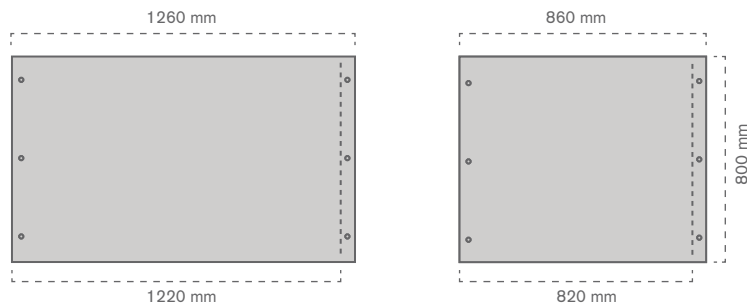

Soluzione L

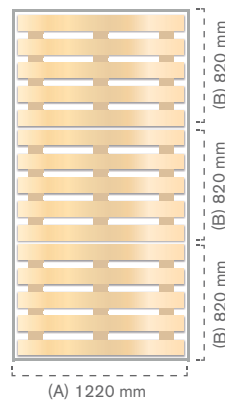

Per 3 pallet:
2 laterali lunghi (A)
6 laterali corti (B)

Soluzione M

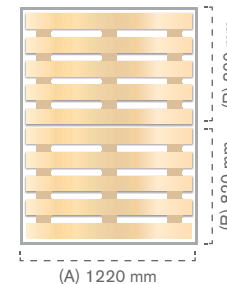

Per 2 pallet:
2 laterali lunghi (A)
4 laterali corti (B)

Soluzione S

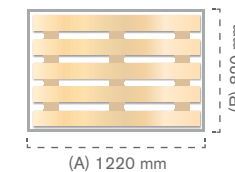



Per 1 pallet:
2 laterali lunghi (A)
2 laterali corti (B)

Sistema copri isola modulare, per rivestire e decorare qualsiasi tipo di isola promozionale. La struttura modulare consente di adattarlo a diversi formati.

Mod.	Ref.	Misure	Mat.		
Lat. Corto	10040300700	860 x 800 mm	PP Cellulare (3,5 mm)	2	2 u
Lat. Lungo	10040300300	1260 x 800 mm	PP Cellulare (3,5 mm)	2	2 u
Lat. Corto	10040300800	860 x 800 mm	Cartone Microcanale (2,5 mm)	2	2 u
Lat. Lungo	10040300400	1260 x 800 mm	Cartone Microcanale (2,5 mm)	2	2 u

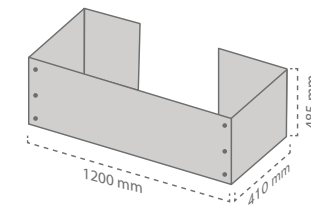
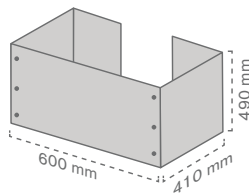
Copri isola **IFCO**



Ref.	Misure	Mat.		
10040301100	600 x 410 x 490 mm	PP Cellulare (3,5 mm)	3	3 u
10040301200	600 x 410 x 490 mm	Cartone Microcanale (2,5 mm)	3	3 u



Ref.	Misure	Mat.		
10040301500	1200 x 410 x 485 mm	PP Cellulare (3,5 mm)	3	3 u
10040301600	1200 x 410 x 485 mm	Cartone Microcanale (2,5 mm)	3	3 u

228 Rivestimenti isola

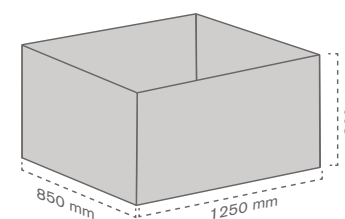
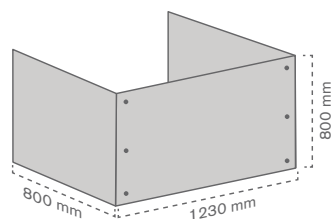
Copri isola per **euro-pallet**



Ref.	Misure	Mat.		
10040301900	1230 x 800 x 800 mm	PP Cellulare (3,5 mm)	1	1 u
10040302000	1230 x 800 x 800 mm	Cartone Microcanale (2,5 mm)	1	1 u



Ref.	Misure	Mat.		
10040302300	1250 x 850 x 800 mm	PP Cellulare (3,5 mm)	1	1 u
10040302400	1250 x 850 x 800 mm	Cartone Microcanale (2,5 mm)	1	1 u

Unione moduli con velcro.

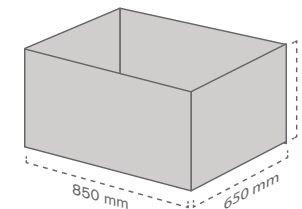
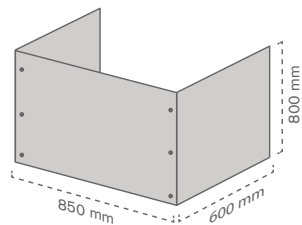
Copri isola per mezzo pallet



Ref.	Misure	Mat.		
10040302700	850 x 600 x 800 mm	PP Cellulare (3,5 mm)	2	2 u
10040302800	850 x 600 x 800 mm	Cartone Microcanale (2, 5 mm)	2	2 u

Ref.	Misure	Mat.		
10040303100	850 x 650 x 800 mm	PP Cellulare (3,5 mm)	1	1 u
10040303200	850 x 650 x 800 mm	Cartone Microcanale (2,5 mm)	1	1 u

Unione moduli con velcro.





flexidecor[®]
SERIES



“ Decora in modo **rapido** e **accattivante** le tue zone promo. Facile, veloce e resistente... è **Flexidecor®** ”

Con Flexidecor® Series potrai rivestire e decorare in maniera accattivante ed economica reparti e spazi espositivi del tuo punto vendita. Puoi scegliere tra vari tipi di colore, spessore, grafiche e dimensioni di stampa.

Flexidecor® Series risponde a esigenze di decorazione periodica e permanente. Ideale per promozioni e ambientazioni di reparto.

La sua versatilità gli consente di essere utilizzato come cartellonistica perimetrale, striscioni da esterni, ma anche per rivestire tavoli e isole promozionali.



Applicazioni



Campagne lancio e stagionali o permanenti



Promozione di un marchio o di una famiglia di prodotti



Decorazione



Classificazione e segmentazione di prodotto



Tipicità regionali



Distaccamento di categoria

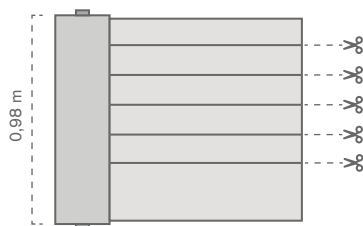

234 Flexidecor® Series

Flexidecor® Print



Parti di bobina personalizzabili in disegno e taglio (minimo 140 mm. altezza).

Flexidecor® Print è il modello più versatile ed ecologico della famiglia. Completamente personalizzabile, è possibile tagliare la bobina in quante parti vuoi.



Ref.	Misure	Mat.		
10040400100	47 x 0,98 m	Telo laminato	1 bobina	1 bobina
10040400200	24 x 0,98 m	Telo laminato	1 bobina	1 bobina
10040400300	12 x 0,98 m	Telo laminato	1 bobina	1 bobina

Flexidecor® tinta unita



Flexidecor® tinta unita è disponibile in vari colori. Si utilizza principalmente per rivestire vetrine, banchi e stand promozionali.



Ref.	Misure	Mat.	Colore		
10040400400	50 x 1 m	PVC (100 my)	ROSSO	1 bobina	1 bobina
10040400500	50 x 1 m	PVC (100 my)	ARANCIONE	1 bobina	1 bobina
10040400600	50 x 1 m	PVC (100 my)	NERO	1 bobina	1 bobina
10040401400	50 x 1 m	PVC (100 my)	BLU	1 bobina	1 bobina

236 Flexidecor® Series

Flexidecor® Yuta



La bobina **Flexidecor® Yuta** è fabbricata con tela di yuta al 100%. Particolarmente indicata per creare ambientazioni rustiche e decorare aree promozionali dedicate a vino, panetteria, prodotti tipici e altro ancora.

Ref.	Misure	Mat.		
10040401300	50 x 1 m	Tela di yuta	1 bobina	1 bobina









Espositori di prodotto

240 Espositori di prodotto

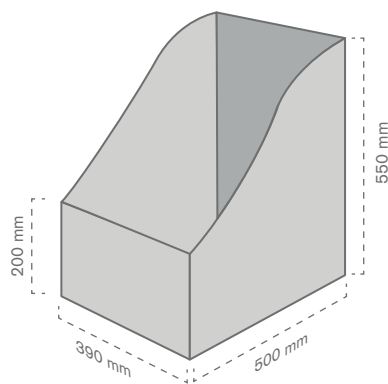
Cesta in vimini modello **XL**



Cesta in vimini naturale inclinata dimensione XL. Ideale per valorizzare e donare un tocco rustico e artigianale al prodotto.

Ref.	Misure	Mat.		
10040500100	390 x 500 x 550 mm	Vimini	1	1 u

Cesta in vimini modello **L**

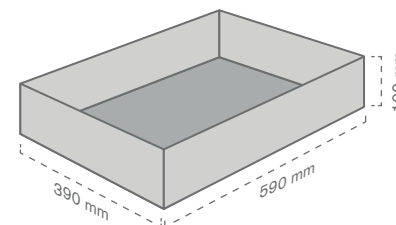



Cesta in vimini naturale dimensione L. Ideale per valorizzare e donare un tocco rustico e artigianale al prodotto.

Ref.	Misure	Mat.		
10040500200	390 x 590 x 100 mm	Vimini	5	5 u

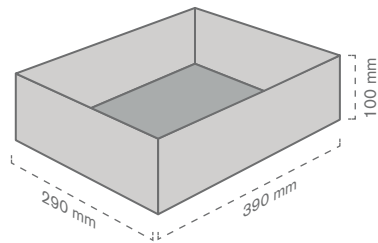
Cesta in vimini modello M





Cesta in vimini naturale dimensione M. Ideale per valorizzare e donare un tocco rustico e artigianale al prodotto.

Ref.	Misure	Mat.		
10040500300	290 x 390 x 100 mm	Vimini	5	5 u

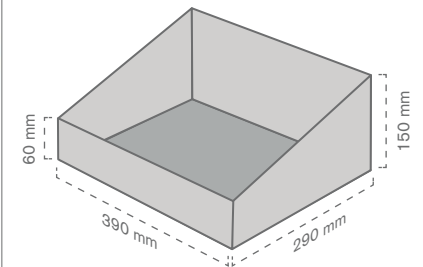
Cesta in vimini **inclinata** modello M



Cesta in vimini naturale inclinata dimensione M. Ideale per valorizzare e donare un tocco rustico e artigianale al prodotto.

Ref.	Misure	Mat.		
10040500400	390 x 290 x 150 mm	Vimini	5	5 u

242 Espositori di prodotto

Espositore da degustazione **Aries**



Espositore da degustazione, progettato per salumeria, prodotti gourmet e frutta. Include porta tovaglioli, porta stuzzicadenti e cestino.

Ref.	Misure	Mat.	Colore		
10040500600	350 x 350 x 1315 mm	Metallo	NERO	1	1 u

Espositore **coppa Aquarius**

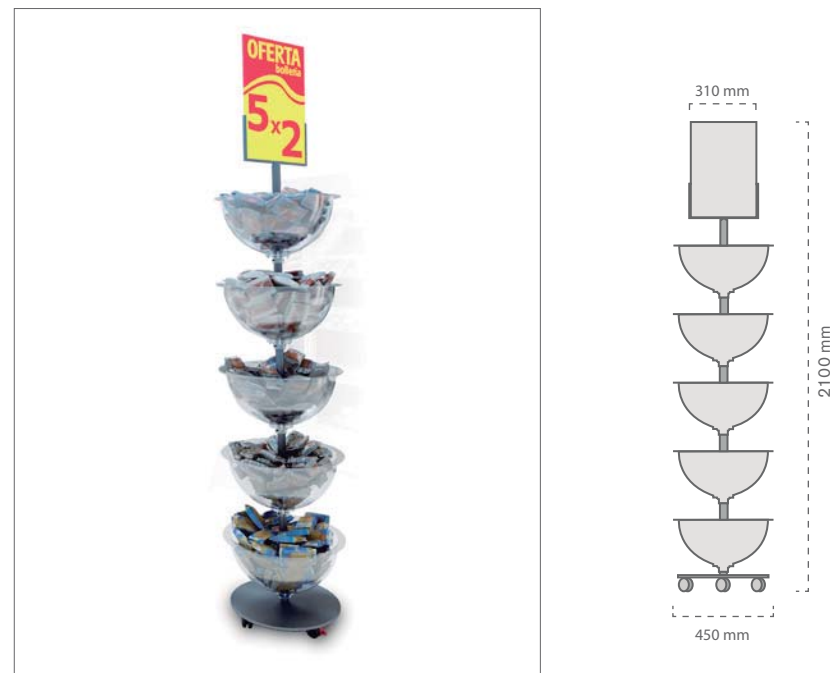

Espositore a forma di coppa per prodotto sciolto. I contenitori porta-prodotti sono regolabili in altezza.

Ref.	Misure	Mat.	Colore		
10040501700	450 x 450 x 2100 mm	Metallo	NERO	1	1 u

Espositore per cross selling Taurus

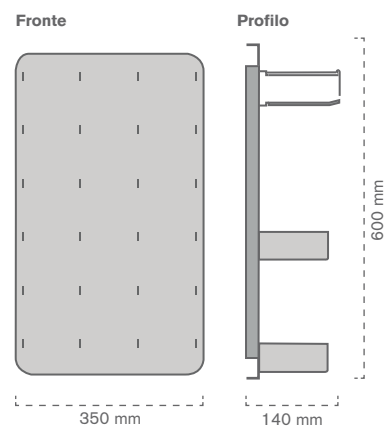

Espositore per cross selling adattabile a testate promozionali, pareti e colonne di corsia o di cassa. Con tagli sul pannello posteriore per posizionare e spostare i suoi accessori porta prodotto.

Ref.	Misure	Mat.	Colore		
10040501600	350 x 140 x 600 mm	Metallo	NERO	1	1 u

A richiesta disponibile in altri colori.

Espositore ECO Bags

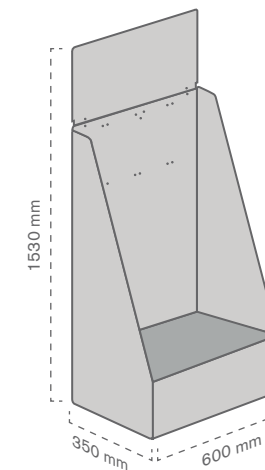

Espositore in polipropilene, per l'esposizione di borse ecologiche.

Ref.	Misure	Mat.		
10040501500	600 x 350 x 1530 mm	PP Cellulare (5 mm)	1	1 u

244 Espositori di prodotto

Espositore per piccoli elettrodomestici

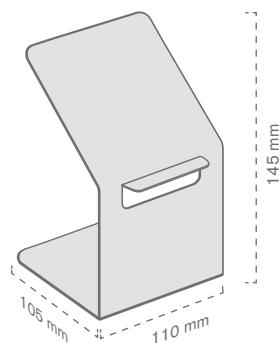

Espositore di piccoli prodotti, in particolare per piccoli elettrodomestici come radio, telefoni, sveglie, orologi, ecc.

Ref.	Misure	Mat.		
10040501800	110 x 105 x 145 mm	PMMA TTE (3 mm)	6	12 u

Espositore per piccoli dispositivi

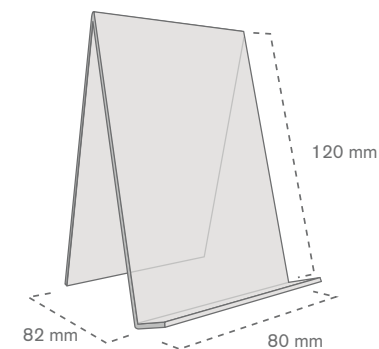

Espositore di piccoli prodotti, in particolare per smartphone o tablet

Ref.	Misure	Mat.		
10040509800	80 x 82 x 120 mm	PMMA TTE (3 mm)	6	12 u

Espositore per piccoli dispositivi



NEW

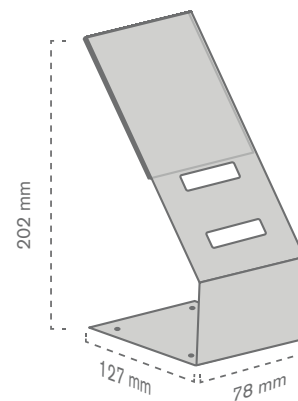

Espositore di piccoli prodotti, in particolare per orologi e cardiofrequenzimetro

Ref.	Misure	Mat.		
10040509700	78 x 127 x 202 mm	PMMA TTE (3 mm)	10	10 u

Espositore per piccoli prodotti per lineare

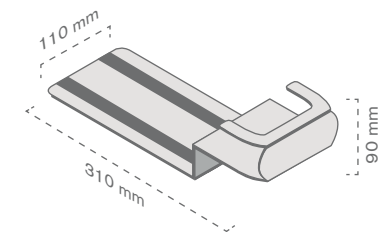

Espositore con calamita disegnato per esporre prodotti nel punto vendita. La sua composizione lo converte in un elemento resistente ed è possibile la sua personalizzazione con l'utilizzo di vinile sulla parte frontale.

Ref.	Misure	Mat.		
10040504000	110 x 310 x 90 mm	PMMA TTE (3 mm)	10	10 u

Stampa non inclusa.

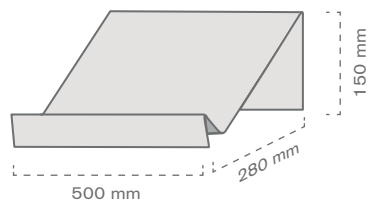
Espositore **inclinato**

Espositore in metacrilato specialmente indicato per inclinare i prodotti ubicati nella parte inferiore, permettendo così una visibilità del prodotto adeguata e favorevole.

Ref.	Misure	Mat.		
10040504100	500 x 280 x 150 mm	PMMA TTE (5 mm)	6	6 u

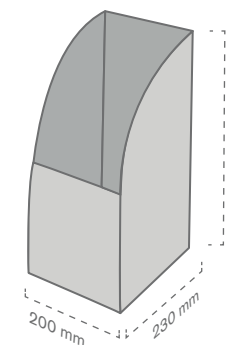
Espositore **Slim box**

Espositore contenitore di prodotti. Questo modello è disegnato per raccogliere ed esibire prodotti, specialmente quegli articoli che hanno una forma allungata, facilitando così la organizzazione del punto vendita

Ref.	Misure	Mat.		
10040504200	200 x 230 x 500 mm	PP Celular (3,5 mm)	5	5 u

Podio

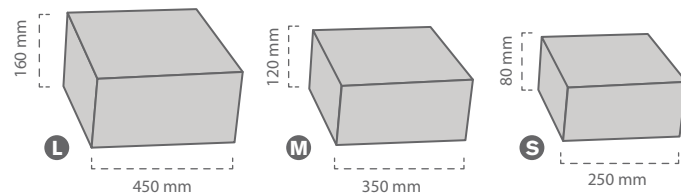

Mod.	Ref.	Misure	Mat.	Colore		
L	10040502800	450 x 450 x 160 mm	Metallo	NERO	1	1 u
M	10040503100	350 x 350 x 120 mm	Metallo	NERO	1	1 u
S	10040503400	250 x 250 x 80 mm	Metallo	NERO	1	1 u

Espositore Ponte

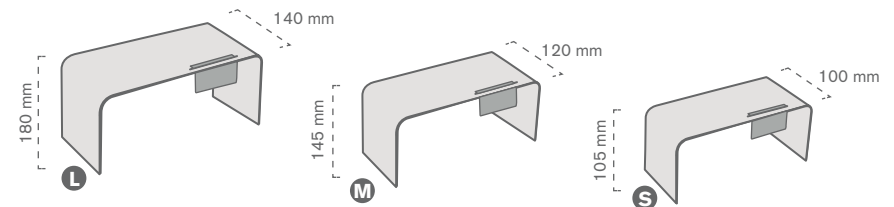

Mod.	Ref.	Misure		Mat.	Colore		
		Espositore	Porta prezzo				
L	10040501900	290 x 140 x 180 mm	53 x 37 mm	PMMA (5 mm)	TTE	4	4 u
L	10040502100	290 x 140 x 180 mm	53 x 37 mm	PMMA (5 mm)	BIANCO	4	4 u
M	10040502200	255 x 120 x 145 mm	53 x 37 mm	PMMA (5 mm)	TTE	4	4 u
M	10040502400	255 x 120 x 145 mm	53 x 37 mm	PMMA (5 mm)	BIANCO	4	4 u
S	10040502500	220 x 100 x 105 mm	53 x 37 mm	PMMA (5 mm)	TTE	4	4 u
S	10040502700	220 x 100 x 105 mm	53 x 37 mm	PMMA (5 mm)	BIANCO	4	4 u

248 Espositori di prodotto

Espositore **Ponte**



NEW

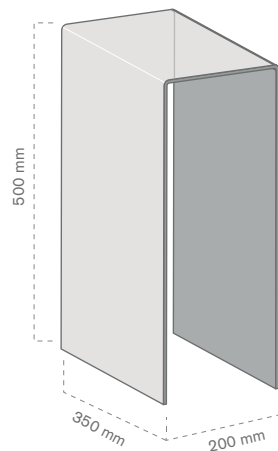

Espositore **Ponte**



NEW

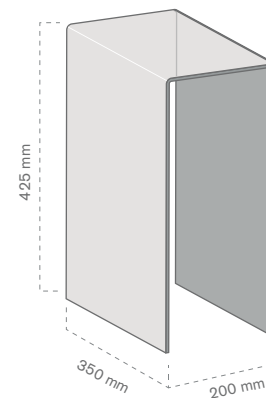

Ref.	Misure	Mat.	Colore		
10040509900	500 x 350 x 200 mm	PMMA (5 mm)	TTE	4	4 u

Ref.	Misure	Mat.	Colore		
10040510000	450 x 350 x 200 mm	PMMA (5 mm)	TTE	4	4 u

Espositore modulare **Professionale**

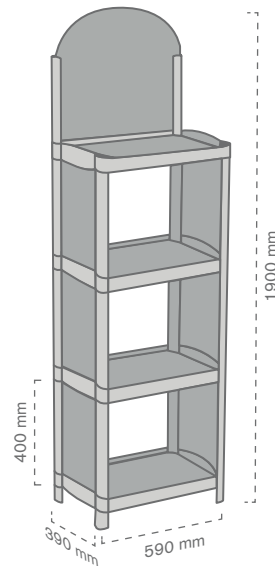

Si tratta di tre moduli, utilizzati come scaffale per la organizzazione e dispozzione di prodotti nel punto vendita. Inoltre, è possibile la personalizzazione de la parte superiore e laterale. Portata massima 30-35 kg per ripiano.

Ref.	Misure	Mat.	Colore		
10040506800	590 x 390 x 1900 mm	PS/ABS	ROSSO	1	1 u
10040506900	590 x 390 x 1900 mm	PS/ABS	NERO	1	1 u
10040507000	590 x 390 x 1900 mm	PS/ABS	BIANCO	1	1 u
Ref.	Descrizione	Mat.	Colore		
10040507600	Personalizzazione	PVC espanso	BIANCO	1	1 u

Espositore modulare **Desk Promoter**

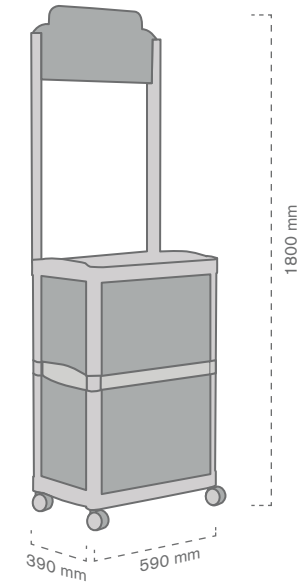

Espositore mobile che può essere utilizzato come piano d'esposizione mobile nel punto vendita. Questo modello può essere personalizzato frontalmente e lateralmente. Portata massima 30-35 kg per ripiano.



Ref.	Misure	Mat.	Colore		
10040507100	590 x 390 x 1800 mm	PS/ABS	NERO	1	1 u
10040507200	590 x 390 x 1800 mm	PS/ABS	BIANCO	1	1 u
Ref.	Descrizione	Mat.	Colore		
10040507600	Personalizzazione	PVC espanso	BIANCO	1	1 u

250 Espositori di prodotto

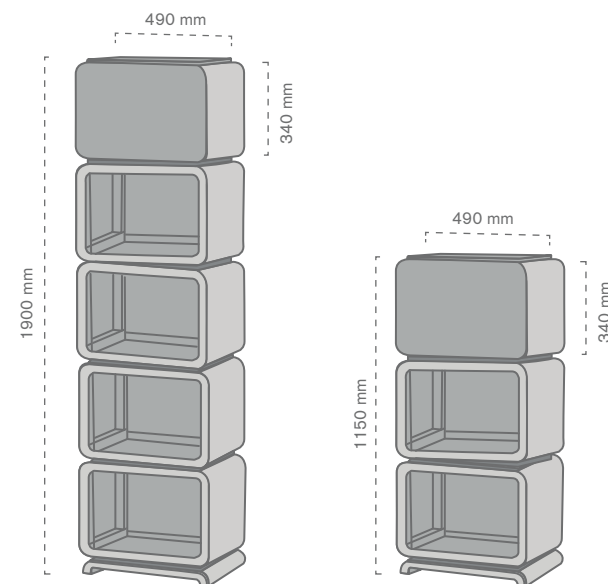
Espositore modulare **Smartower**



Espositori automontabile. Questo modello si adatta a tutti i generi di necessità, potendolo utilizzare come piano od espositore. La sua composizione è personalizzabile con una portata massima per ripiano di 25 kg (solo se i ripiani hanno la stessa direzione). Ogni modulo misura 490 x 326 x 340 mm. La versione a 3 moduli include un vassoio collocato nella parte superiore.

Ref.	Mat.	Módulos	Colore		
10040505500	PS/ABS	3	BIANCO	1	1 u
10040505600	PS/ABS	3	NERO	1	1 u
10040505900	PS/ABS	5	BIANCO	1	1 u
10040506000	PS/ABS	5	NERO	1	1 u

Accessori per espositore modulare **Smartower**

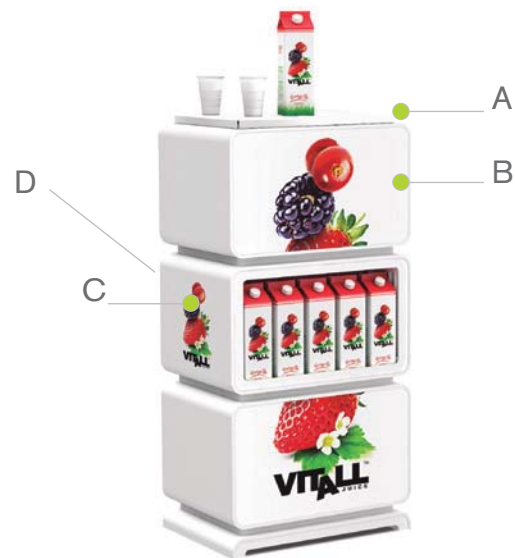

Articoli per la decorazione e la luce di Smartower.

A: Vassoio / B: Pannello decorativo / C: Vinile adesivo / D: Porta lampada

Ref.	Misure	Mat.	Colore		
A 10040506500	420 x 300 x 20 mm	PS/ABS	BIANCO	1	1 u
A 10040506600	420 x 300 x 20 mm	PS/ABS	NERO	1	1 u
B 10040507300	483 x 323 x 2 mm	PVC Espumado	BIANCO	1	1 u
B 10040507400	483 x 323 x 1 mm	PET-G	BIANCO	1	1 u
C 10040508400	340 x 300 mm (X2)	Vinilo	BIANCO	1	1 u
D 10040506700	483 x 323 x 2 mm	PVC Espumado	BIANCO	1	1 u

Espositore **Box**

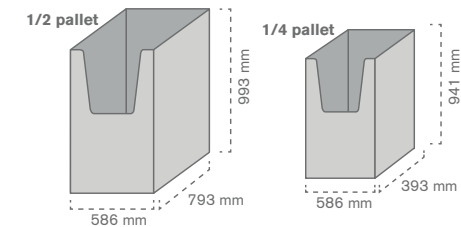

Colore*/Referenza				Misure	Mat.		
186 C	347 C	BIANCO	NERO				
10040500700	10040500800	10040500900	10040501000	586 x 793 x 993 mm	PP Cellulare (5 mm)	2	2 u
10040501100	10040501200	10040501300	10040501400	586 x 393 x 941 mm	PP Cellulare (5 mm)	2	2 u





Espositori porta volantini

254 Espositori porta volantini

Espositore porta volantini "Libra"

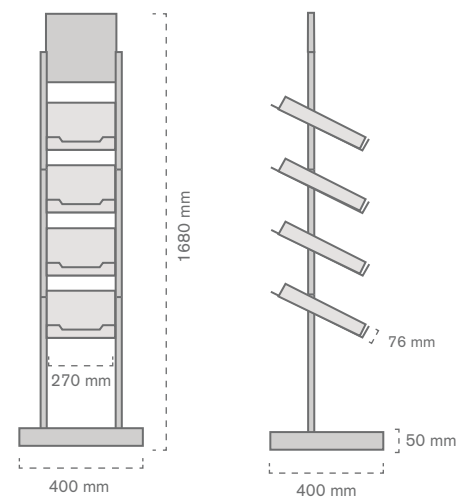

Espositore metallico con 4 ripiani per esporre volantini e cataloghi in formato A4.

Ref.	Misure		Mat.	Colore	🛒	📄
	Generale	Volantini				
10040600100	400 x 400 x 1680 mm	A4	Metallo e PMMA	RAL 7040	1	1 u
10040600200	400 x 400 x 1680 mm	A4	Metallo e PMMA	NERO	1	1

Espositore porta volantini "Gemini"

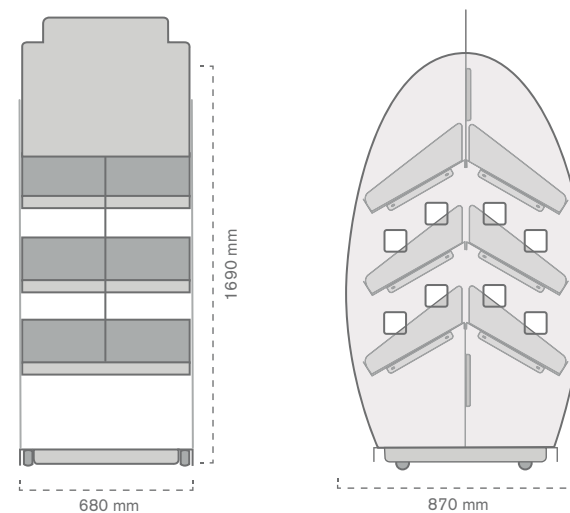



Resistente ed elegante, offre grande capacità di carico, per volantini e brochure formato A4. Pratico e maneggevole grazie alle sue ruote nascoste.

Ref.	Misure		Mat.	Colore	🛒	📄
	Generale	Volantini				
10040600300	680 x 870 x 1690 mm	320 x 400 mm	Metallo e PMMA	NERO	1	1 u
10040600400	680 x 870 x 1690 mm	320 x 400 mm	Metallo e PMMA	RAL 3020	1	1 u

256 Espositori porta volantini

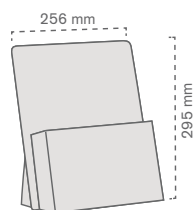

Porta volantini **A4**



Ref.	Misure volante	Mat.		
10040600500	A4	PETG	10	10 u

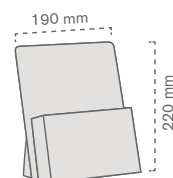

Porta volantini **A5**

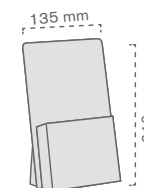

Ref.	Misure volante	Mat.		
10040600600	A5	PETG	10	10 u

Porta volantini **1/3 di A4**



Ref.	Misure volante	Mat.		
10040600700	1/3 A4	PETG	10	10 u

Espositore da lineare con **adesivo cellulosa**

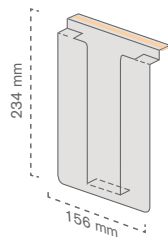

Ref.	Misure volantino	Mat.		
10040600800	1/3 A4	PVC	50	50 u

Espositore da lineare **per profilo**

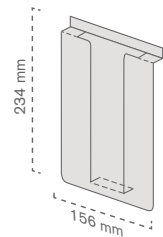

Ref.	Misure volantino	Mat.		
10040600900	1/3 A4	PVC	50	50 u

Espositore da lineare con **profilo basculante**

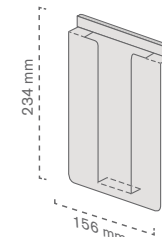



Ref.	Misure volantino	Mat.		
10040601000	1/3 A4	PVC	25	25 u

258 Espositori porta volantini

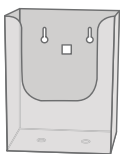

Porta volantini da **parete**



Ref.	Misure volantino	Mat.		
10040601100	A4	Plastica	10	10 u
10040601200	A5	Plastica	10	10 u
10040601300	A6	Plastica	10	10 u

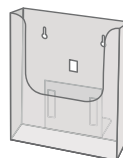

Porta volantini da **ripiano**

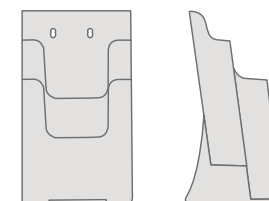

Ref.	Misure volantino	Mat.		
10040601400	A4	Plastica	10	10 u
10040601500	A5	Plastica	10	10 u
10040601600	A6	Plastica	10	10 u

Porta volantini **doppio** da ripiano



Ref.	Misure volantino	Mat.		
10040602100	A4	Plastica	2	2 u
10040601900	A5	Plastica	4	4 u
10040601700	1/3 A4	Plastica	4	4 u

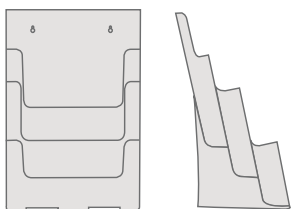

Porta volantini **triplo** da ripiano

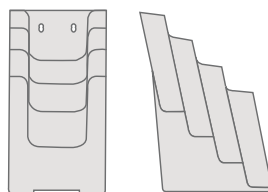

Ref.	Misure volantino	Mat.		
10040602200	A4	Plastica	2	2 u

Porta volantini **quadruplo** da ripiano



Ref.	Misure volantino	Mat.		
10040602000	A5	Plastica	2	2 u
10040601800	1/3 A4	Plastica	2	2 u

Porta volantini **con morsetto** per lineare

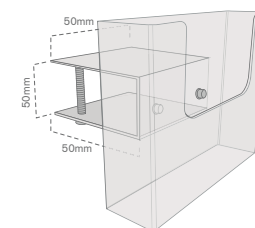

NEW

Ref.	Misure volantino	Mat.		
10040605000	A6	Plastica	2	2 u





Totem

262 Totem

Totem "Wall Street"

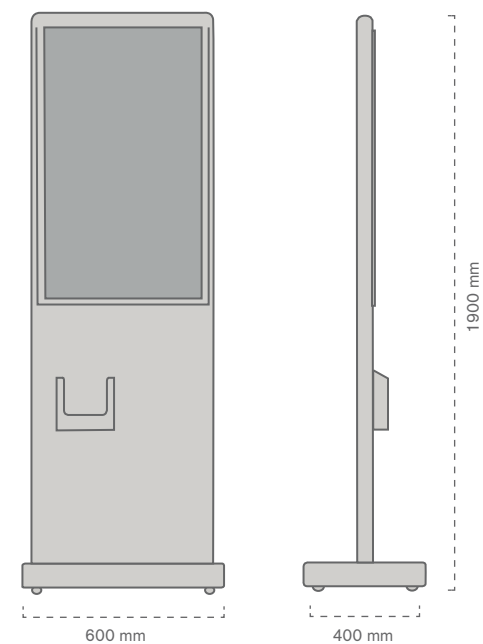



Totem di due facce ideale per campagne promo e comunicazioni periodiche, comprende tasca porta volantini e profilo a U per l'aggiornamento delle locandine. Grazie alle ruote può essere facilmente spostato.

Ref.	Misure			Mat.	Colore		
	Generale	Messaggio	Volantino				
10040700100	600 x 400 x 1900 mm	480 x 900 mm	A5	Metallo	RAL 3003	1	1 u

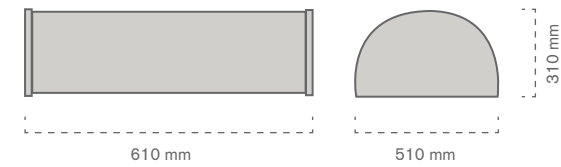
Base metallica per totem



La struttura permette di incorporare pannelli fino a 10 mm. di spessore. Rende facile la sostituzione delle comunicazioni. Pannello non incluso.



Ref.	Misure	Mat.	Colore		
10040700200	610 x 510 x 310 mm	Metallo	NERO	1	1 u

264 Totem

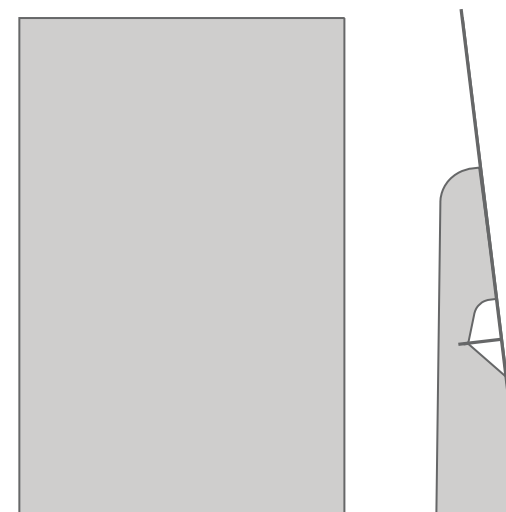
Totem "Montreal"





Realizzabile in materiali differenti, si compone di un pannello principale e di una base d'appoggio. Forma e grafica personalizzabili.

Mod.	Ref.	Misure pannello	Mat.		
L	10040700300	980 x 1980 mm	Cartone Doppio Microcanale (4 mm)	1	1 u
M	10040700500	980 x 1480 mm	Cartone Doppio Microcanale (4 mm)	1	1 u
S	10040701500	740 x 980 mm	Cartone Doppio Microcanale (4 mm)	1	1 u
L	10040700400	980 x 1980 mm	PP Cellulare (5 mm)	1	1 u
M	10040700600	980 x 1480 mm	PP Cellulare (5 mm)	1	1 u
S	10040701600	740 x 980 mm	PP Cellulare (5 mm)	1	1 u

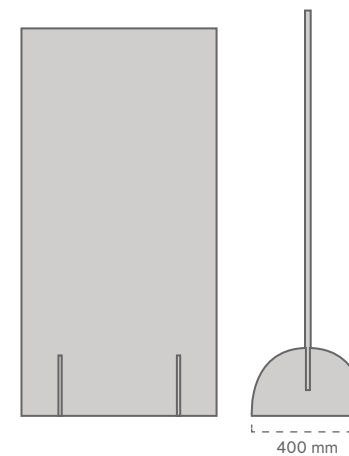
Totem "Hércules"



Totem a due facce realizzabile in materiali differenti, si compone di un pannello principale e di una base d'appoggio. Dimensione, forma e grafica personalizzabili, rispettando gli ingombri indicati nell'illustrazione.



Ref.	Misure	Mat.		
10040700700	680 x 1980 mm	Cartone a Nido d'Ape (10 mm)	1	1 u
10040700800	980 x 1380 mm	Cartone a Nido d'Ape (10 mm)	1	1 u
10040700900	680 x 1980 mm	Sandwich di PVC (10 mm)	1	1 u
10040701000	980 x 1380 mm	Sandwich di PVC (10 mm)	1	1 u
10040701700	680 x 1980 mm	Sandwich di PVC (19 mm)	1	1 u
10040701800	980 x 1380 mm	Sandwich di PVC (19 mm)	1	1 u

266 Totem

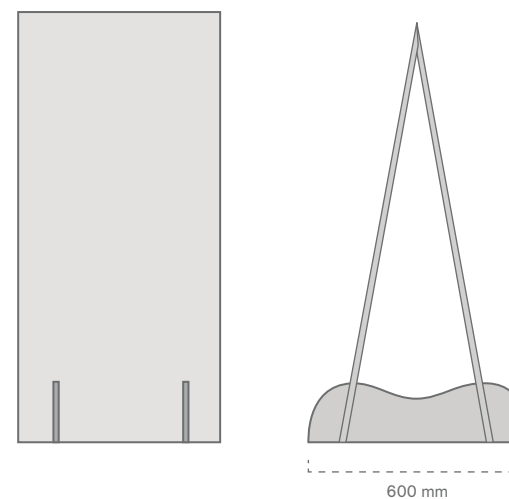
Totem "Eiffel"



Trepiede bifacciale realizzabile in vari tipi di materiali.

Ref.	Misure	Mat.		
10040701900	980 x 1480 mm	Cartone Doppio Microcanale (4 mm)	1	1 u
10040702300	650 x 1480 mm	Cartone Doppio Microcanale (4 mm)	1	1 u
10040702000	980 x 1480 mm	PP Cellulare (5 mm)	1	1 u
10040702400	650 x 1480 mm	PP Cellulare (5 mm)	1	1 u

GP x3

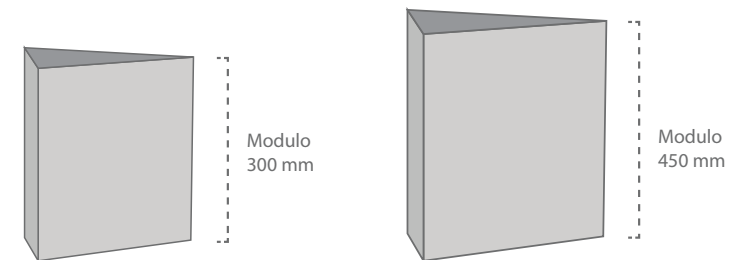



Totem modulare in cartone. Modello composto da più moduli triangolari che, impilati l'uno con l'altro consentono di costruire un totem delle dimensioni desiderate. Facciate completamente personalizzabili.

Ref.	Misure modulo	Mat.		
10040701300	450 x 450 mm	Cartone Microcanale (2,5 mm)	4	4 u
10040701400	300 x 300 mm	Cartone Microcanale (2,5 mm)	4	4 u

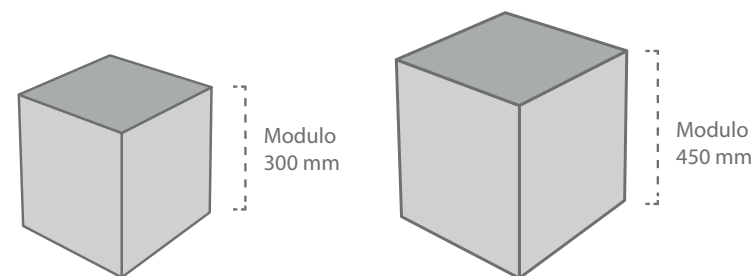
GP x4



Totem modulare in cartone. Modello composto da più moduli a forma di cubo che, impilati l'uno con l'altro consentono di costruire un totem delle dimensioni desiderate. Facciate completamente personalizzabili.

Ref.	Misure modulo	Mat.		
10040701100	450 x 450 mm	Cartone Microcanale (2,5 mm)	4	4 u
10040701200	300 x 300 mm	Cartone Microcanale (2,5 mm)	4	4 u

GP x6

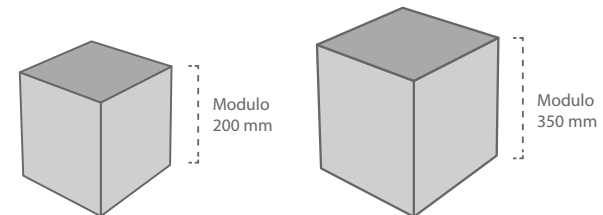

Grazie alla sua forma geometrica e alla completa personalizzazione grafica, consente di esporre e decorare in modi e stili differenti.

Ref.	Misure modulo	Mat.		
10040702100	350 x 350 mm	Cartone Microcanale (2,5 mm)	4	4 u
10040702200	200 x 200 mm	Cartone Microcanale (2,5 mm)	4	4 u



-10% off
back to School

-10% off
back to School

-10% off
back to School

-10% off
back to School

back to School
with
Fresh Market
by GRUPO GP

-10% off
back to School

-10% off
back to School

back to School with Fresh Market
-10% off
27,99€

back to School with Fresh Market
-10% off
62,85€

back to School with Fresh Market
-10% off
62,85€

back to School with Fresh Market

New 2642€
back to School

selección

New 2642€

-10% off
back to School

back to School
-10% off
Fresh Market

back to School with Fresh Market
-10% off

Bags

Arc

Ink Cartridges
Pencils

BU

selección

Gate XL



NEW

XL

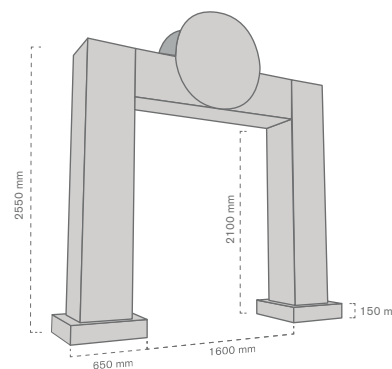

XXL

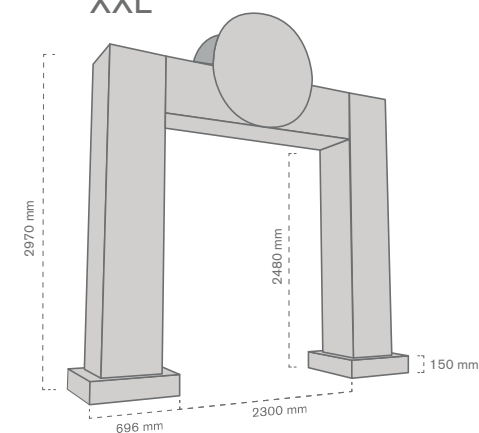

Totem di polipropilene cellulare particolarmente adatto per evidenziare sezioni, entrate o promozioni specifiche nel punto di vendita. Questo modello è personalizzabile nel design e nella forma.

Ref.	Misure	Mat.		
10040702510	3700 x 2970 mm	P.P. Cellulare (3 mm)	1	1 u
10040702500	2900 x 2550 mm	P.P. Cellulare (3 mm)	1	1 u

* Pannello circolare non incluso

272 Totem

Totem Doppio Nero

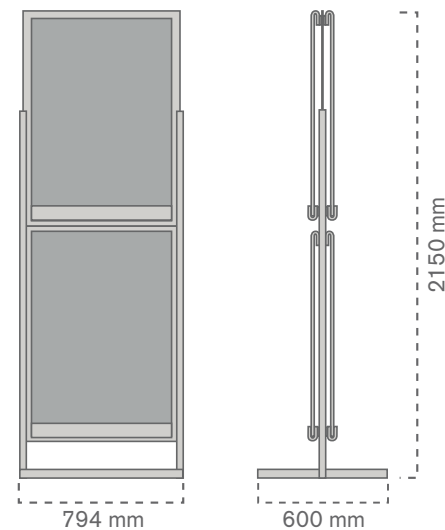

NEW

Ref.	Misure	Mat.		
12000040200	794 x 600 x 2150 mm	Metallo	1	1 u

* Include 4 display di PVC da 680 x 952 mm





Leggii

Leggio "Pegasus"

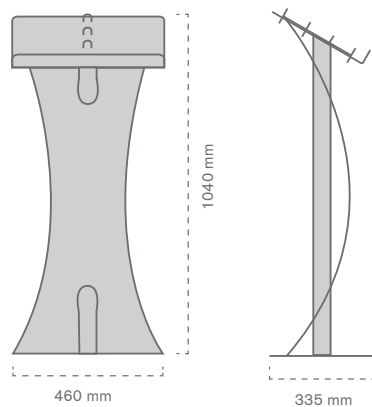

Leggio in metallo per l'esposizione di cataloghi formato A4. Completo di quattro anelli per raccoglitori da 5 mm.

Ref.	Misure		Mat.	Colore	Icona 1	Icona 2
	Generale	Anille				
10040800100	460 x 335 x 1040 mm	25 x 30 mm	Metallo	RAL 3020	1	1 u

Leggio "Pegasus" formato orizzontale

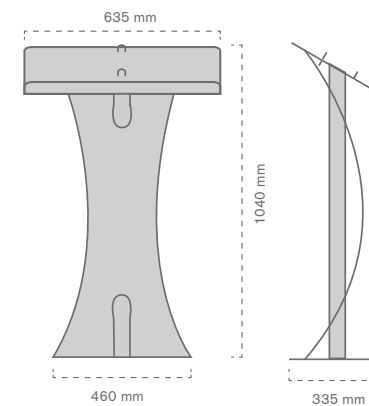

Leggio in metallo per l'esposizione di N.1 o 2 cataloghi formato A4 orizzontale.

Ref.	Misure		Mat.	Colore	Icona 1	Icona 2
	Generale	Anille				
10040800400	365 x 335 x 1040 mm	25 x 30 mm	Metallo	RAL 3020	1	1 u

Leggio per iPad

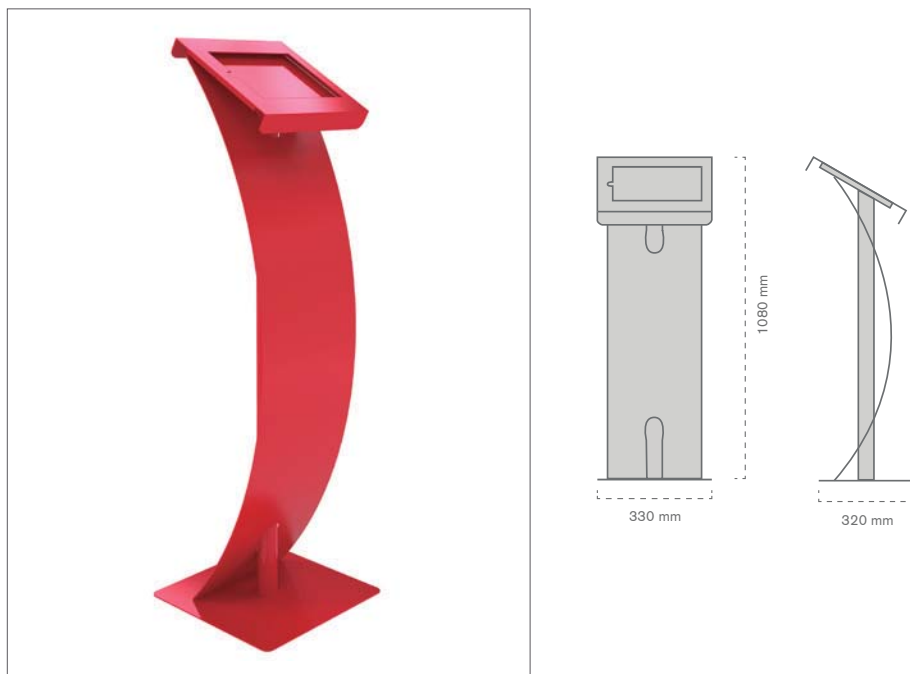

Leggio metallico per ipad, con canalina nascondi filo. Disponibile per tutti i modelli in commercio

Ref.	Misure	Mat.	Colore	Icone		
10040800500	330 x 320 x 1080 mm	Metallo	RAL 3020	1	1 u	iPad 2/ iPad 3
10040800600	330 x 320 x 1080 mm	Metallo	RAL 3020	1	1 u	iPad Air

Leggio "Ara"



Leggio in polipropilene, facile e veloce da montare. Sul frontale monta una tasca formato A3 porta messaggi. Grafica personalizzabile.

Ref.	Misure		Mat.	Colore	Icone	
	Generale	Messaggio				
10040800300	440 x 357 x 1075 mm	A3	PP Cellulare (5 mm) e PVC	BIANCO	3	3 u





Coperture antitaccheggio

280 Coperture antitaccheggio

Copertura antitaccheggio "Aghar"

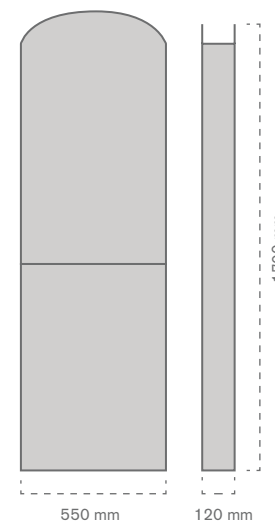

Copertura in polipropilene cellulare, composta da due parti per facilitarne l'installazione. Grafica personalizzabile.

Ref.	Misure	Mat.		
10040900100	550 x 120 x 1700 mm	PP Cellulare (2 mm)	2	2 u

Copertura antitaccheggio "Diamante"

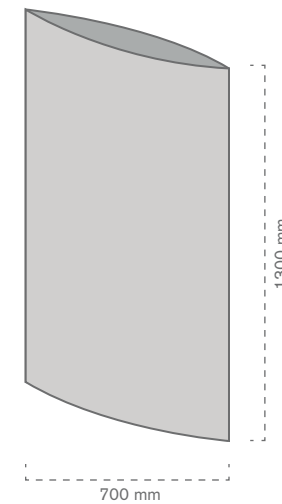

Copertura antitaccheggio in cartone microcanale. Grafica personalizzabile.

Ref.	Misure	Mat.		
10040900200	700 x 1300 mm	Cartone Microcanale (2,5 mm)	2	2 u





Box porta messaggi

284 | Box porta messaggi

Box porta messaggi con **tasca e serratura**

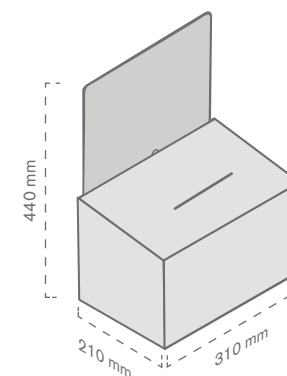

Casella suggerimenti con serratura. Questo modello è dotato di due chiavi ed una tasca superiore formato A4, per l'inserimento di qualsiasi tipo di messaggio o comunicazione.

Ref.	Misure		Mat.	1	1 u
	Generale	Display			
10041000100	316 x 210 x 435 mm	A4	PMMA TTE (5 mm)	1	1 u

Cassetta porta messaggi **standard**

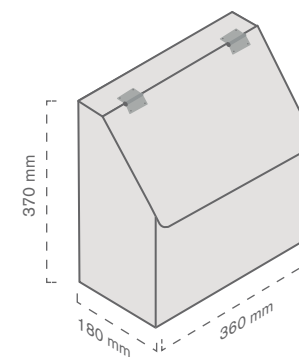

Modello con apertura nella parte superiore. Fabbricato in metacrilato trasparente.

Ref.	Misure	Mat.		
10041000200	360 x 180 x 370 mm	PMMA TTE (3 mm)	1	1 u

Instant
Coffee

New!

Fresh Market
Normal
Instant
Coffee

New!

Instant
200 g
2,44€

**soluble
coffee**

ROASTED

Black
COFFEE

Cube
Plus

Nutritional Facts
Tablita Nutricional

CHOCOLATE
COFFEE

PREPARED
FULL FLAVORED
INSTANT GROUND

Accessori per fissaggio

*Pinze e basette
Ganci e accessori
Elementi per fissaggio magnetico
Nastri adesivi*





Pinze e basette

290 Pinze e basette

Pinza adesiva a U e base trasparente per separatori

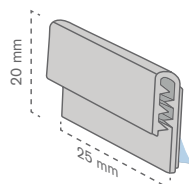

Ref.	Misure	Mat.		
10050100100	25 x 20 mm	PVC TTE	100	100 u

Pinza adesiva flessibile a U.
Provvista di adesivo cellulosa, consente la sospensione di cartelli fino a 3 mm. di spessore. Larghezza personalizzabile.

Pinza adesiva T

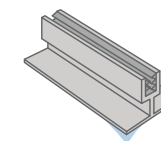

Ref.	Misure	Mat.		
10050100300	76 x 13 mm	PVC TTE	100	100 u
10050100400	25 x 13 mm	PVC TTE	100	100 u

Pinza adesiva flessibile a T.
Provvista di supporto flessibile e adesivo spugnoso, consente la sospensione di cartelli fino a 3 mm. di spessore. Larghezza personalizzabile.

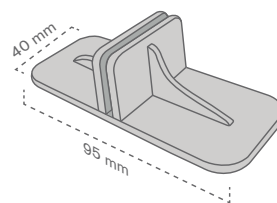

Ref.	Misure	Mat.		
10050100200	95 x 40 mm	PC TTE	25	25 u

Base TTE per separatori.
Base particolarmente indicata per supportare articoli di 3 mm. di spessore.

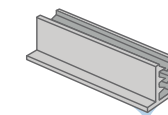
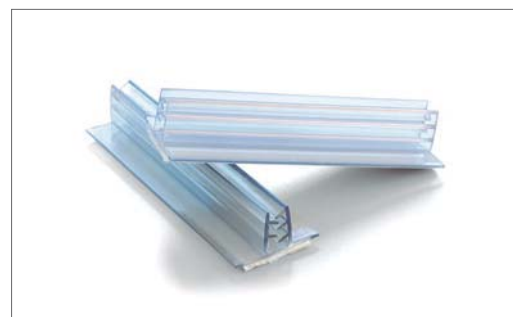

Ref.	Misure	Mat.		
10050100500	76 x 13 mm	PVC TTE	100	100 u
10050100600	25 x 13 mm	PVC TTE	100	100 u

Pinza a T adesiva.
Provvista di adesivo spugnoso, consente la sospensione di cartelli fino a 3 mm. di spessore. Larghezza personalizzabile.

Pinza porta cornici

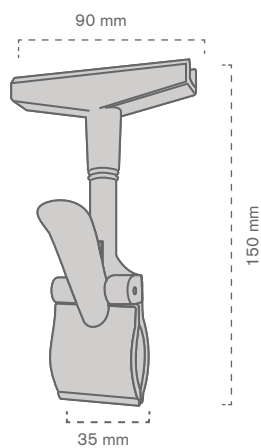

Articolo disponibile in vari colori. Permette di posizionare cornici agganciandosi a barre o supporti fino a 30 mm. di diametro.

Ref.	Misure	Colore		
10050101100	90 x 150 mm	BIANCO	10	10 u
10050102400	90 x 150 mm	TTE	10	10 u
10050102300	90 x 150 mm	NERO	10	10 u

Pinza porta tasche

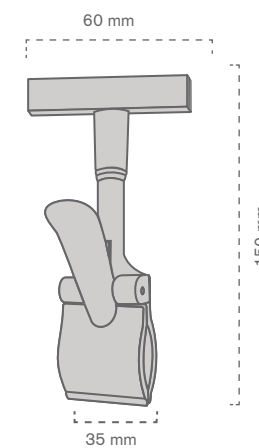



Articolo disponibile in vari colori. Permette di posizionare tasche (formato massimo A4) agganciandosi a barre o supporti fino a 30 mm. di diametro.

Ref.	Misure	Colore		
10050102900	60 x 150 mm	BIANCO	10	10 u
10050102100	60 x 150 mm	TTE	10	10 u
10050102200	60 x 150 mm	NERO	10	10 u

292 Pinze e basette

Pinza per stopper



Ref.	Misure	Mat.		
10050101200	35 x 51 mm	PP Semitrasparente	100	100 u

Pinza stopper perforata.
Efficace per fissare stopper e separatori ai profili di linea-re.

Pinza per profilo con etichetta elettronica

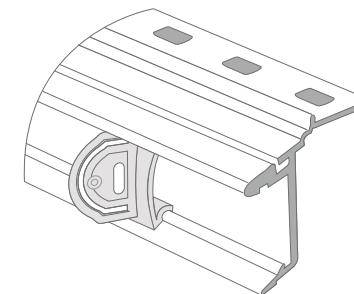

Ref.	Misure	Mat.		
10050101400	35 x 40 mm	PP Semitrasparente	100	100 u

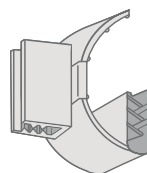

Pinza perforata per ETE.
Ideale per fissare stopper e separatori a profili per etichette elettroniche.

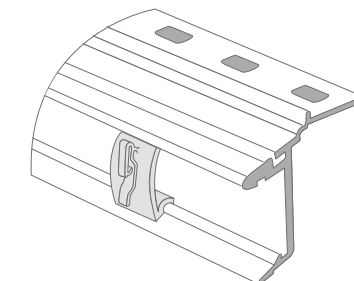

Ref.	Misure	Mat.		
10050101300	45 x 51 mm	PVC TTE	100	100 u

Pinza stopper regolabile.
La pinza regolabile permette di posizionare lo stopper a differenti altezze e angolazioni.



Ref.	Misure	Mat.		
10050101500	15 x 40 mm	PP Semitrasparente	100	100 u

Pinza frontale ETE.
Ideale per fissare stopper e separatori a profili per etichette elettroniche.

Pinza per profilo SL

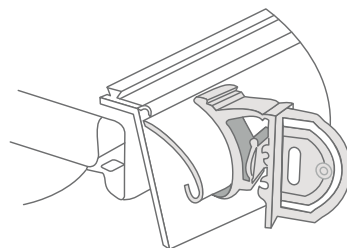
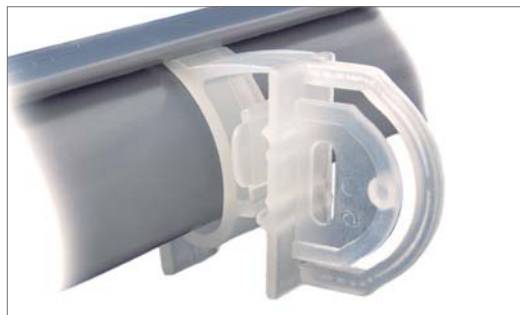

Ref.	Misure	Mat.		
10050102500	35 x 45 mm	PP Semitrasparente	100	100 u

Pinza stopper perforata SL.
Efficace per fissare stopper e separatori a profili SlimLine.

Pinza per profilo FL

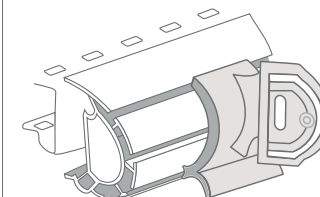

Ref.	Misure	Mat.		
10050102700	40 x 40 mm	PP Semitrasparente	100	100 u

Pinza stopper perforata FL.
Efficace per fissare stopper e separatori a profili FL.

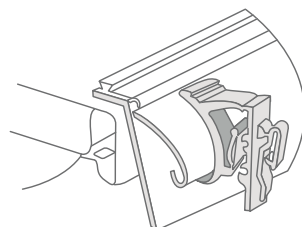

Ref.	Misure	Mat.		
10050102600	35 x 30 mm	PP Semitrasparente	100	100 u

Pinza frontale SL.
Efficace per fissare display a profili SlimLine.

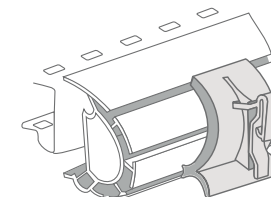

Ref.	Misure	Mat.		
10050102800	30 x 20 mm	PP Semitrasparente	100	100 u

Pinza frontale FL.
Efficace per fissare display a profili FL.

294 Pinze e basette

Pinza con snodo

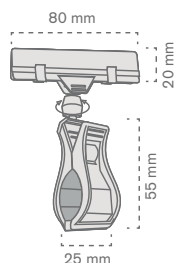

Ref.	Misure		Colore	🛒	📄
	Pinza	Supporto			
10050100700	25 x 55 mm	80 x 20 mm	TTE	25	25 u

Pinza porta cartello snodata.
Progettata per agganciarsi a barre fino a 25 mm. di diametro. Può supportare cartelli fino a 10 mm. di spessore.

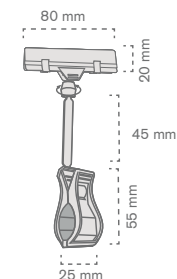

Ref.	Misure		Colore	🛒	📄
	Prolunga	Supporto			
10050100800	45 mm	80 x 20 mm	TTE	25	25 u

Pinza 45 mm.
Progettata per agganciarsi a barre fino a 25 mm. di diametro. Può supportare cartelli fino a 10 mm. di spessore.

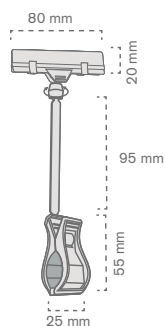

Ref.	Misure		Colore	🛒	📄
	Prolunga	Supporto			
10050100900	95 mm	80 x 20 mm	TTE	25	25 u

Pinza porta cartello snodata 95mm.
Progettata per agganciarsi a barre fino a 25 mm. di diametro. Può supportare cartelli fino a 10 mm. di spessore.

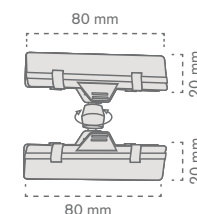



Ref.	Misure		Colore	🛒	📄
	Pinza	Supporto			
10050101000	80 x 20 mm	80 x 20 mm	TTE	25	25 u

Pinza doppia snodata
Questo modello consente di agganciarsi e supportare cartelli fino a 10 mm di spessore.

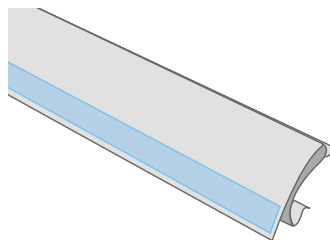
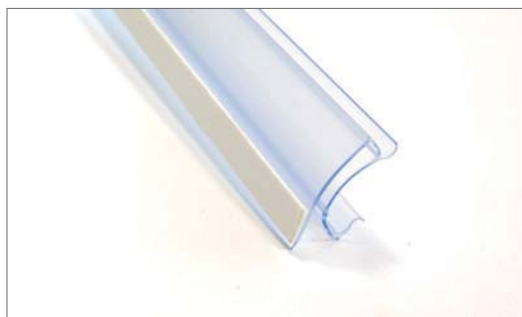

Basi per display

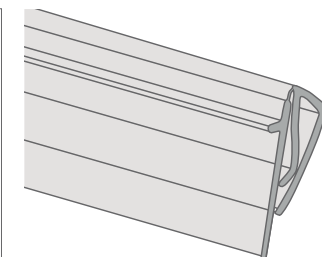

Ref.	Misure	Colore		
10050101600	175 mm	TTE	100	100 u
10050101700	80 mm	TTE	100	100 u

Profilo basculante SlimLine. Base con adesivo spugnoso d'aggancio a profili SL (SlimLine), per tasche porta prezzo. Disponibile in due formati.



Ref.	Misure	Colore		
10060800500	1050 mm	TTE	100	100 u
10050101900	210 mm	TTE	100	100 u
10050101800	150 mm	TTE	100	100 u

Profilo basculante. Base d'aggancio a profili standard. Basculante con adesivo, per tasche porta prezzo. Disponibile in diversi formati.



Ref.	Misure	Colore		
10050102000	155 x 37 mm	BIANCO	100	100 u

Profilo Castello per ET. Base d'aggancio con adesivo cellulosa, per profili di etichette elettroniche.





Ganci e accessori

298 Ganci e accessori

Gancio doppio

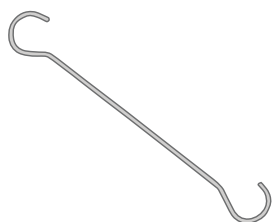

Ref.	Misure	Mat.	Icone	
10050200100	1000 mm	Metallo	50	50 u
10050200200	700 mm	Metallo	50	50 u
10050200300	500 mm	Metallo	50	50 u
10050200400	300 mm	Metallo	50	50 u
10050200500	150 mm	Metallo	50	50 u

Gancio a esse 40 e 25 mm



Ref.	Misure		Mat.	Icone	
	Lunghezza	Ø Materiale			
10050200600	40 mm	4 mm	Metallo	100	100 u
10050200700	25 mm	3 mm	Metallo	100	100 u

Gancio a esse 68 mm

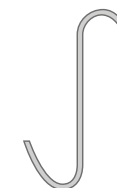

Ref.	Misure		Mat.	Icone	
	Lunghezza	Ø Materiale			
10050200800	68 mm	2 mm	Metallo	100	100 u

Gancio a C

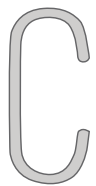

Ref.	Misure		Mat.		
	Lunghezza	Ø Materiale			
10050200900	39 mm	2 mm	Metallo	100	100 u

Ventosa



Ref.	Ø	Colore		

Ventosa con gancio

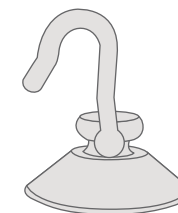



Ref.	Ø	Colore		

300 Ganci e accessori

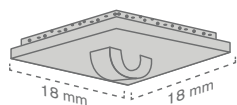

Gancio adesivo **18 mm**

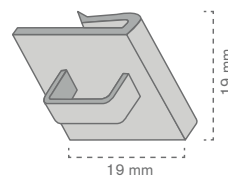

Ref.	Misure	Colore		
10050201400	18 x 18 mm	BIANCO	100	100 u

Gancio per **profilo controsoffitto**



Ref.	Misure	Mat.		
10050201500	19 x 19 mm	PP Semitrasparente	100	100 u

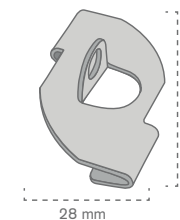

Gancio metallico per **controsoffitto**



Ref.	Misure	Colore		
10050201600	28 x 40 mm	METALLO	50	50 u
10050201700	28 x 40 mm	BIANCO	50	50 u

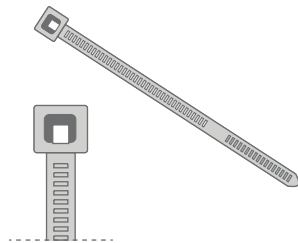
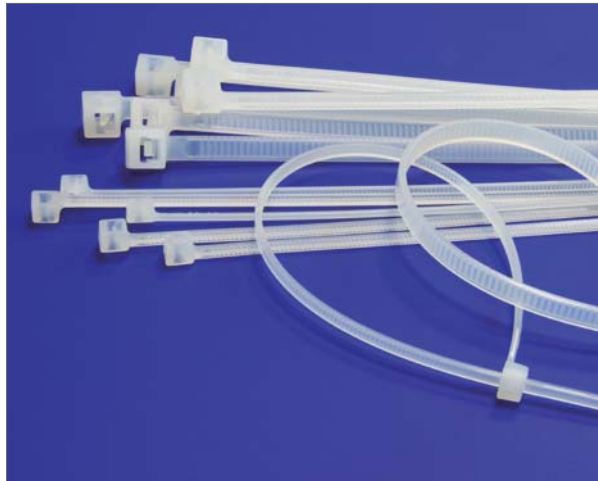

Pacchetto di **fascette autobloccanti** 100 unt.



Ref.	Misure	Mat.		
10050201800	310 x 4,8 mm	PVC BCO	1	1 u
10050201900	200 x 4,8 mm	PVC BCO	1	1 u
10050202000	165 x 2,5 mm	PVC BCO	1	1 u
10050202100	100 x 2,4 mm	PVC BCO	1	1 u

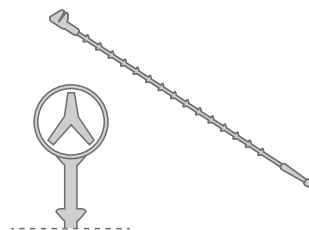

Pacchetto di fili di **sicurezza autobloccanti** 500 unt.

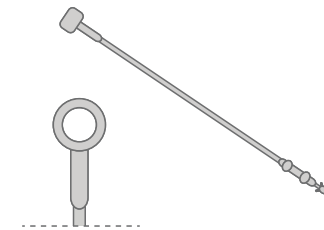
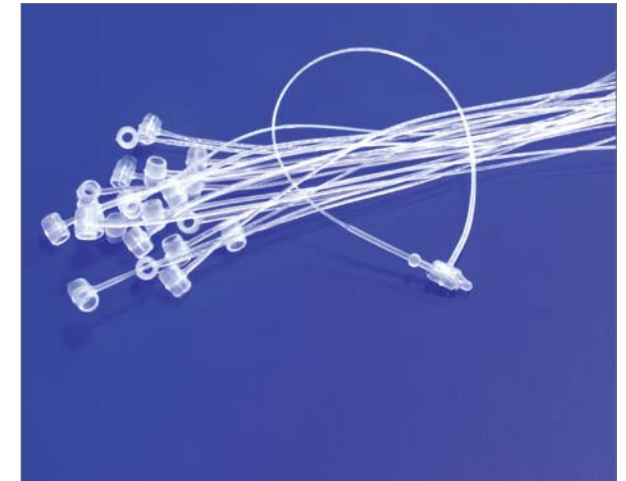

Ref.	Misure	Mat.		
10050202200	125 mm	PVC BCO	1	1 u

Pacchetto di fili di sicurezza **TTE** 500 unt.



Ref.	Misure	Mat.		
10050202300	125 mm	PVC TTE	1	1 u

302 Ganci e accessori

Cavo acciaio 2 mm e morsetti



Pezzo A

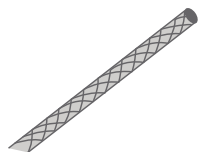

Pezzo B

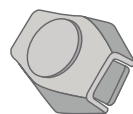

Pezzo	Ref.	Misure	Mat.		
A	10050203500	100 m	Acciaio	1	1 u
B	10050203600	Per Ø2 mm	Metallo	100	100 u

Moschettone metallico

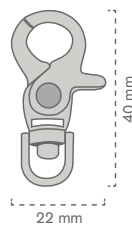
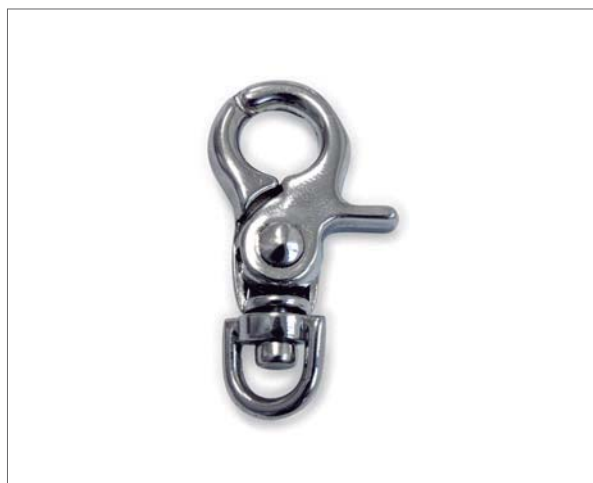

Ref.	Misure	Mat.		
10050203700	22 x 40 mm	Metallo	100	100 u

Grippe

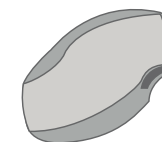

Ref.	Misure	Resistenza	Mat.		
10050203800	5 m	45 kg	Metallo	10	10 u
10050203900	3 m	45 kg	Metallo	10	10 u

Pistola per fili da cartellino e complementi



Ref.	Modello		
10050203200	Tacher II	1	1 u

**Pistola per fili da cartellino
Tacher II**
Per etichettatura normale



Ref.	Modello		
10050208200	Arrow Fina	1	1 u

**Pistola per fili da cartellino
Arrow Fina**
Per etichettatura di precisione



Ref.	Modello	Misure		
10050203300	Tacher II	25 mm	1	1 u
10050208300	Tacher II	40 mm	1	1 u
10050209000	Arrow fina	25 mm	1	1 u
10050208300	Arrow fina	40 mm	1	1 u

**Pacchetto di fili da cartelli-
no 1000 unt.**





Ref.	Modello		
10050204400	Tacher II	1	1 u
10050208900	Arrow fina	1	1

Ago per pistola /fili

304 Ganci e accessori

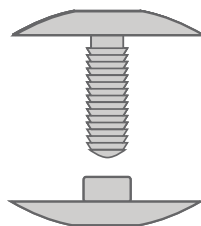
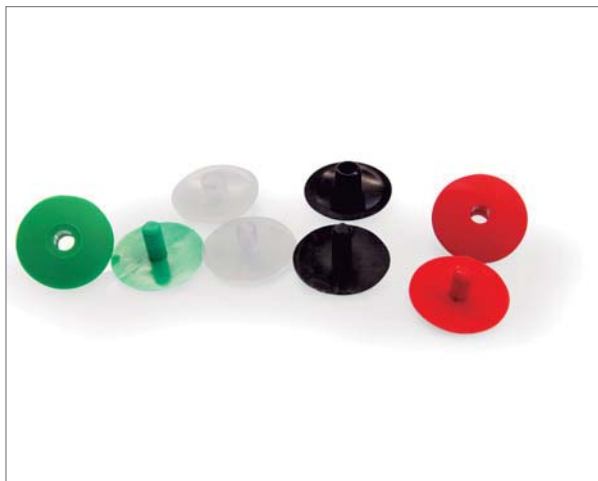
Bottoni **28 mm**



Colore	Misure			
	28 x 10 mm	28 x 12,5 mm		
186 C	10050202800	10050202400	100	100 u
347 C	10050202900	10050202500	100	100 u
TTE	10050203000	10050202600	100	100 u
NERO	10050203100	10050202700	100	100 u







Elementi per fissaggio magnetico

308 Elementi per fissaggio magnetico

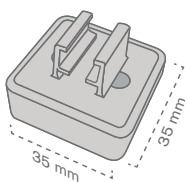

Aggancio calamitata



Ref.	Misure	Colore		
10050300500	35 x 35 mm	BIANCO	10	10 u

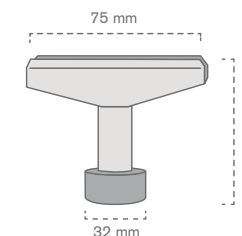

Supporto calamitato base.
Supporto per cornici da applicare a ripiani in metallo.



Ref.	Misure	Colore		
10050301000	75 x 32 x 54 mm	TTE	20	20 u

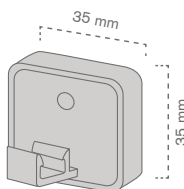

T calamitata per cornice.
Supporto calamitato a forma di T per cornici.

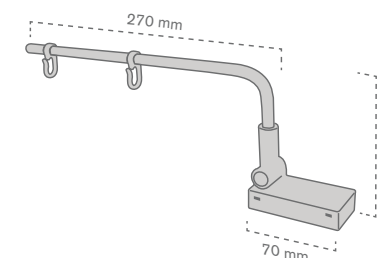

Ref.	Misure	Colore		
10050300600	35 x 35 mm	BIANCO	10	10 u

Supporto calamitato da parete.
Supporto per cornici da applicare a pareti in metallo.





Ref.	Misure		
10050300700	340 x 110 mm	10	10 u

Braccetto calamitato.
Supporto calamitato efficace per fissare separatori verticali al ripiano.

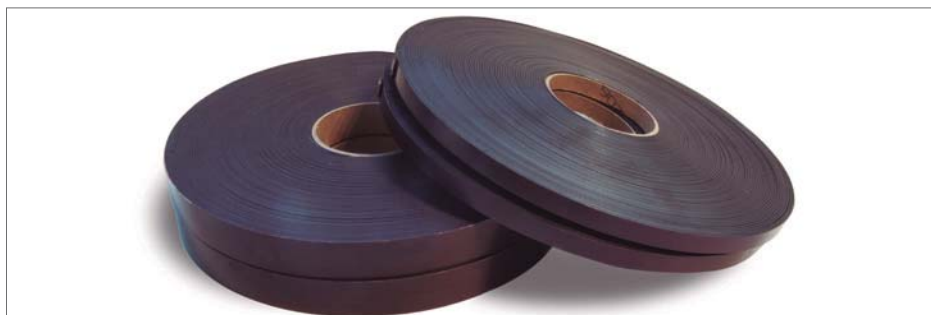
Aggancio calamitata



Ref.	Misure	Mat.		
10050300800	30 m x 25,4 mm	Calamita	1	1 u
10050300900	30 m x 12,7 mm	Calamita	1	1 u

Rotolo calamita adesiva.
Utile per fissare cartellonistica a pareti e supporti metallici.



Ref.	Ø	Resistenza	Colore		
10050300100	47 mm	15,5 kg	BIANCO	5	5 u
10050300200	36 mm	8,5 kg	BIANCO	5	5 u
10050300300	32 mm	6,5 kg	BIANCO	5	5 u
10050300400	25 mm	3,5 kg	BIANCO	5	5 u

Gancio magnetico.
Utile per sospendere cartellonistica o prodotti a parete supporti metallici.



Ref.	Misure	Mat.		
10050301100	30 m x 615 mm	Calamita	1	1 u

Bobina calamitata.
Bobina bianca caratterizzata da lato nero magnetico e lato bianco stampabile. Permette di decorare schiene di gondola e superfici metalliche.







Nastri adesivi

312 Nastri adesivi

Biadesivo **cellulosa**





Consigliato su carta.

Ref.	Misure		
10050400100	50 m x 30 mm	18	18 u
10050400200	50 m x 19 mm	15	15 u
10050400300	50 m x 12 mm	24	24 u

Biadesivo **spugnoso**





Utile per fissare cartellonistica pesante a pareti e superfici.

Ref.	Misure		
10050400400	66 m x 30 mm	14	14 u
10050400500	66 m x 19 mm	22	22 u

Biadesivo **removibile**





Utile per fissare moquette al pavimento e decorazioni leggere a TV e vetri. Resistente e facile da rimuovere, non lascia residui sulle superfici.

Ref.	Misure		
10050400600	50 m x 50 mm	32	32 u
10050400700	50 m x 30 mm	56	56 u

Velcro adesivo bianco





Utile per fissare cartellonistica attacca e stacca a superfici lisce.

Modello	Ref.	Misure		
Maschio	10050400800	25 m x 20 mm	1	1 u
Femmina	10050400900	25 m x 20 mm	1	1 u

Rotolo calamita adesiva



Utile per fissare cartellonistica a pareti e supporti metallici.

Ref.	Misure		
10050300800	30 m x 25,4 mm	1	1 u
10050300900	30 m x 12,7 mm	1	1 u

Eco fruits Healthy food

fruits & vegetables Eco fruits Healthy food

50% OFF on 2nd item purity PERSONAL CARE PRODUCTS

special offer 1 25 €

50% OFF on 2nd item purity PERSONAL CARE PRODUCTS

PERSONAL CARE PRODUCTS

PERSONAL CARE PRODUCTS

special offer 1 69

special offer 2 69

shower gel silk glow purity on 2nd item 1,25€

Personal care

special offer

special offer: green apples 1,25€

Do you know about apples? Best varieties apple with less calories 44 grams of protein, 28 calories and 1.6 grams of dietary fiber.

-50% -50% -50% -50% -50% -50%

THE WAY OF SAVINGS Market

Comunicazione aerea

*Testate promozionali
Complementi
Kakemono
FastUP
Tasche formato XL
Indicatori di corsia
Piccoli accessori
Profili per cartellonistica*





Testate promozionali



- La comunicazione di testata è uno strumento fondamentale per dare grande impatto alle campagne di comunicazione nel punto vendita. Il suo utilizzo varia in base a criteri di tipo commerciale e di marketing. In funzione di questo vi proponiamo un'ampia gamma di soluzioni, capace di rispondere a qualsiasi necessità di tipo tecnico e visivo, legata al tipo d'acquisto, rotazione e formato del prodotto.

Data la crescente richiesta di dare maggior risalto ai prodotti a banco, abbiamo allargato la nostra famiglia di testate includendo anche quelle di corsia, capaci di dare alla comunicazione di corsia un valore aggiunto e di spezzare la monotonia visiva di corsie molto lunghe.



Applicazioni



Campagne lancio e stagionali o permanenti



Promozione di un marchio o di una famiglia di prodotti



Decorazione



Classificazione e segmentazione di prodotto



Tipicità regionali



Distacco di categoria

320 Testate promozionali

Braccetto a T

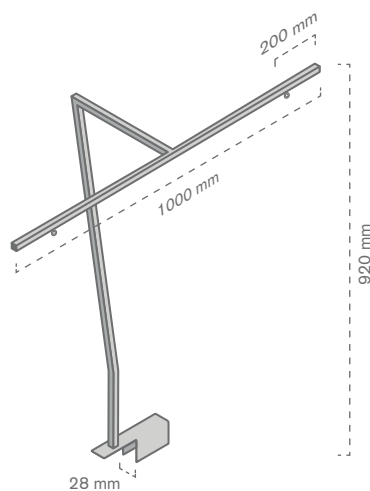

Consente di collocare un cartello per ogni testata di gondola, si aggancia a barre di forza o spigoli con spessore di 28 mm.

Ref.	Misure	Mat.	Colore		
10060100100	1000 x 920 mm	Metallo	RAL 3020	1	10 u

Braccetto triangolare

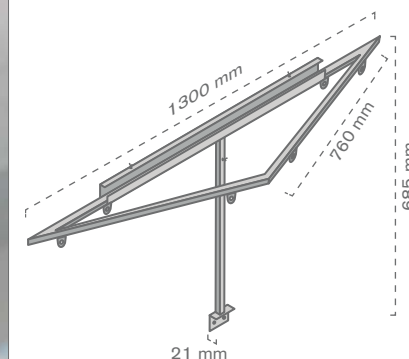
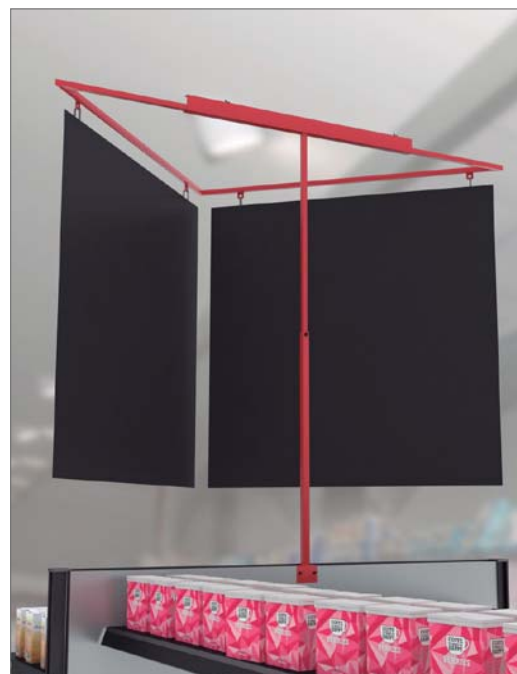

Consente di separare le comunicazioni di testata, supportando due cartelli contemporaneamente. Si aggancia a barre di forza o spigoli con spessore di 28 mm.

Ref.	Misure	Mat.	Colore		
10060100200	1300 x 400 x 685 mm	Metallo	RAL 3020	1	10 u

Kit barra di forza per cremagliera

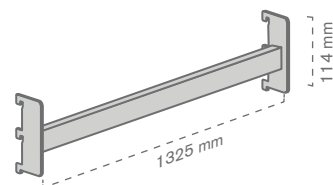

Barra di forza con aggancio cremagliera. Modello particolarmente indicato per gancio cremagliera con passo da 25 e 50.

Ref.	Misure	Mat.	Colore		
10060100300	1325 mm	Metallo	RAL 9001	5	5 u

Kit barra di forza aggancio parte superiore

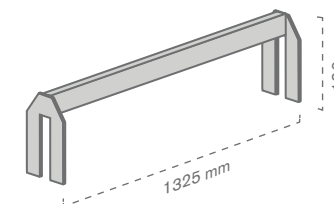

Barra di forza con aggancio particolarmente indicato per fissaggio nella parte superiore della gondola.

Ref.	Misure	Mat.	Colore		
10060101500	1325 mm	Metallo	RAL 9001	5	5 u

322 Testate promozionali

Supporto porta cartelli per gondola

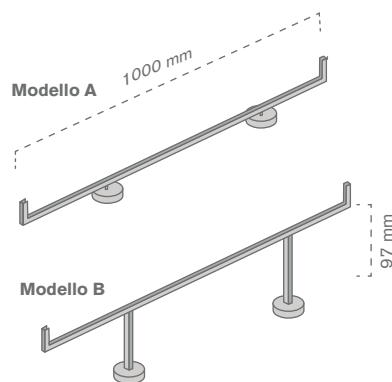

Supporto calamitato per fissare cartelli nella parte superiore della gondola. Questo modello supporta cartelli da 10 mm. di spessore.

Mod.	Ref.	Misure	Mat.	Colore		
A	10060101300	1000 x 82 mm	Metallo	NERO	5	5 u
B	10060101400	1000 x 179 mm	Metallo	NERO	5	5 u

A richiesta disponibile in altri colori.

Testata frontale

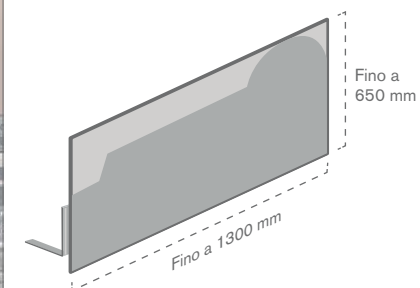

Mette in risalto promozioni e selezioni di prodotti su testate e lineari di corsia. Comprende due supporti a L per il fissaggio al tetto di gondola. Grafica e forma personalizzabili mantenendo gli ingombri indicati.

Ref.	Misure	Mat.		
10060100400	1300 x 650 mm	PVC Espanso	1	6 u

Testata frontale bifacciale

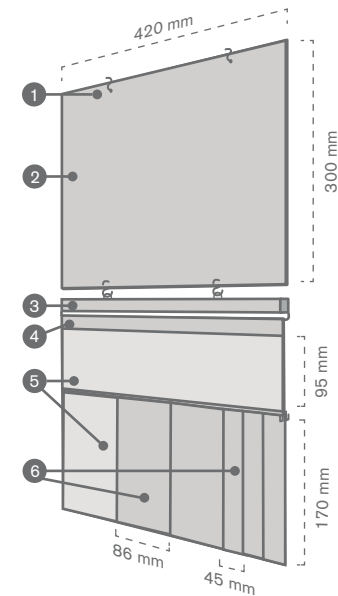

Pack testata frontale composto da: quattro ganci a Esse (1), pannello superiore (2), barra porta cartelli da 450 mm. (3), pannello di PVC espanso (4), quattro tasche trasparenti (5) e un kit di libretti numerici di due formati (6).

Ref.	Misure	Mat.		
10060100500	420 x 605 mm	Sandwich d'Alluminio e PVC Espanso (3 mm)	1	10 u

324 Testate promozionali

Testata **frontale** a una **facciata**

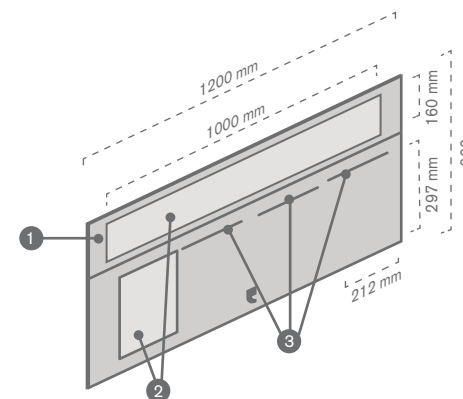

Testata frontale di una facciata composta da: pannello base (1), due tasche trasparenti (2), e tre guide per libretti numerici formato A4 (3). Modello a una facciata.

Ref.	Misure	Mat.		
10060100600	1200 x 600 mm	PP Cellulare (3,5 mm)	1	10 u

Testata triangolare

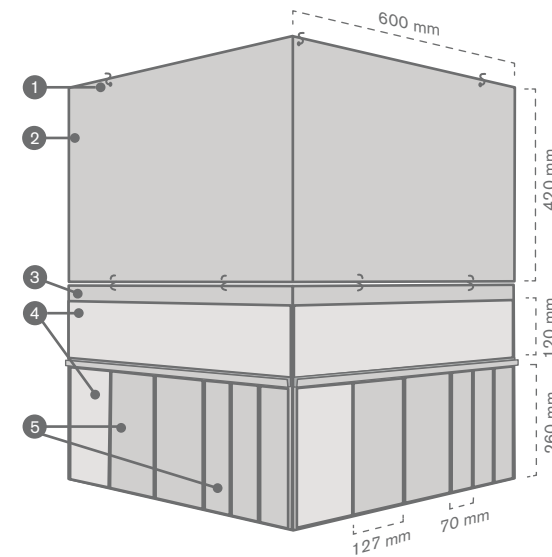

Pack testata triangolare composto da: sette ganci a Esse (1), pannello superiore a V monofacciale (2), pannello di PVC espanso (3), quattro tasche trasparenti (4) e un kit di libretti numerici di due formati (5).

Ref.	Misure (1 facciata)	Mat.		
10060100700	600 x 845 mm	Sandwich d'Alluminio e PVC Espanso (3 mm)	1	10 u

326 Testate promozionali

Testata **triangolare**

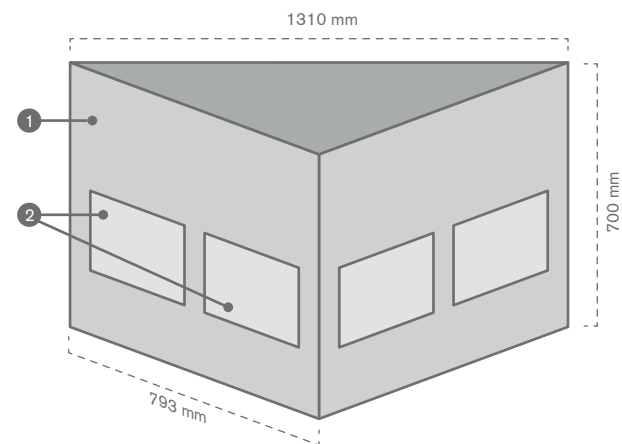

Testata promozionale a forma triangolare composta da un pannello base (1) e quattro tasche trasparenti formato A4 orizzontale (2). Consente di mettere e togliere prezzo e informazioni. Modello personalizzabile.

Ref.	Misure	Mat.		
10060100800	1310 x 447 x 700 mm	PP Cellulare (5 mm)	1	10 u

Testata triangolare

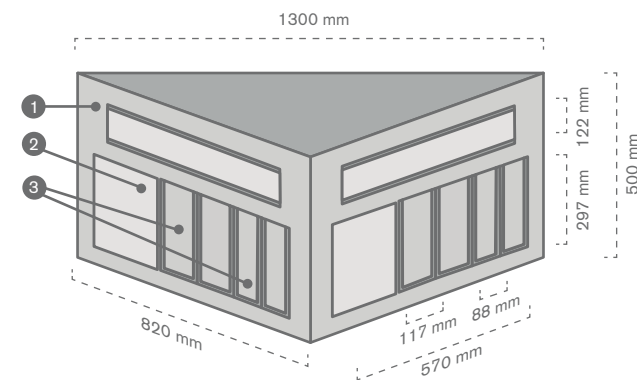

Testata promozionale a forma triangolare composta da un pannello base (1), due tasche trasparente formato A4 (2) e un kit di libretti (3). Ideale per testate promozionali. Modello personalizzabile.

Ref.	Misure	Mat.		
10060100900	1300 x 500 x 500 mm	PP Cellulare (5 mm)	1	10 u

328 Testate promozionali

Testata **aerea offerta**



NEW

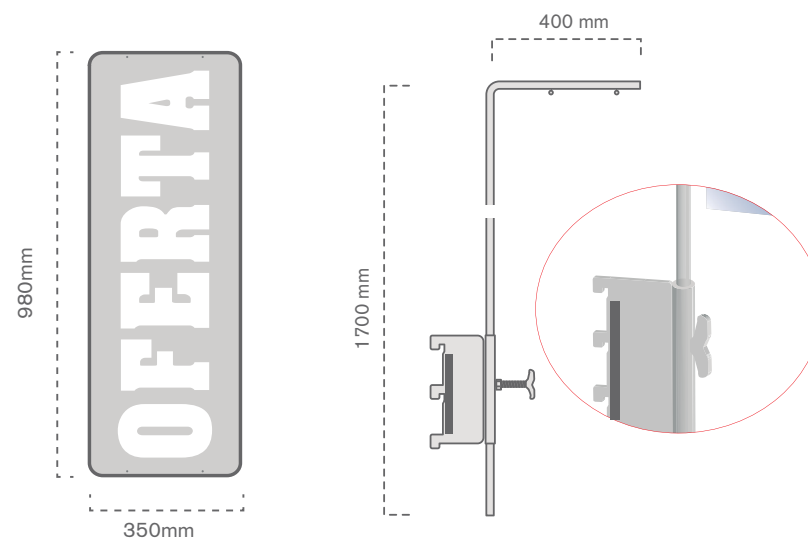

Testata promozionale aerea stampa bifacciale con fori sopra e sotto.

Barra regolabile in altezza mediante dado ad allette, si fissa mediante cremagliera al mobile.

Ref.	Misure	Mat.		
10060101600	350 x 980 mm	PVC espumado	5	5 u

Ref.	Misure	Mat.	Colore		
10060101700	1700 x 400 mm	Metallo	BIANCO	1	1 u





Complementi

Laterali

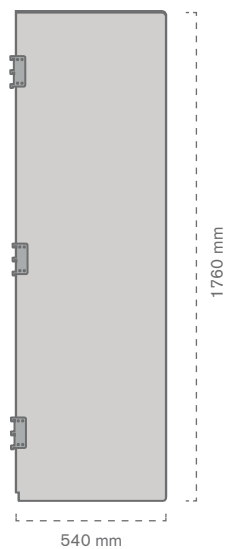

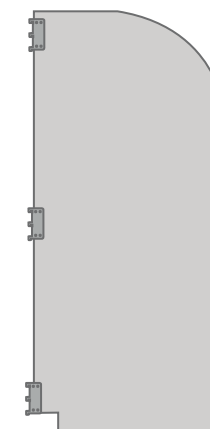

Pannello laterale in legno per testate, con aggancio speciale in metallo dentellato (passo 25 e 50), specifico per cremagliera.

Ref.	Misure	Mat.		
10060200100	540 x 1760 mm	Legno, metallo e vinile	2	10 u



Pannello laterale per gondole di corsia. Disponibile in due formati. Grafica personalizzabile. Aggancio dentellato con passo da 25 e 50.

Ref.	Misure	Mat.		
10060200200	753 x 1855 mm	PMMA (4 mm), metallo e vinile	2	10 u
10060200300	753 x 1540 mm	PMMA (4 mm), metallo e vinile	2	10 u

Laterali

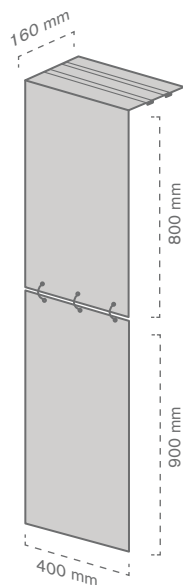

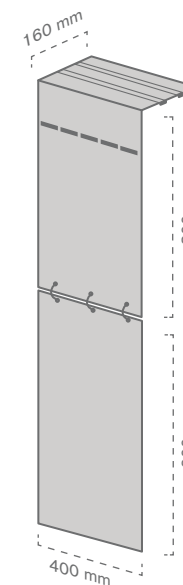

Doppio pannello laterale in PVC, unito da 3 anelli. Si fissa a tetti di gondola e ripiani, grazie alla doppia striscia di velcro inclusa nell'aletta superiore. Grafica personalizzabile.

Ref.	Misure	Mat.		
10060200400	400 x 160 x 1705 mm	PVC BCO (700 my)	20	20 u



Doppio pannello laterale in PVC, unito da 3 anelli. Si fissa a tetti di gondola e ripiani grazie alla doppia striscia di velcro inclusa nell'aletta superiore. Studiato per agganciare fino a 5 strisce da cross merchandising.

Ref.	Misure	Mat.		
10060200900	400 x 160 x 1705 mm	PVC BCO (700 my)	20	20 u



Vedi i modelli di strisce per cross merchandising. Strisce non incluse.

334 Complementi

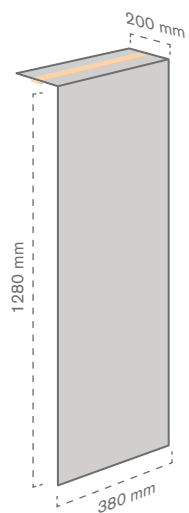
Laterali



Pannello laterale in cartone. Si fissa a tetti di gondola e ripiani grazie alla striscia di adesivo cellulosa inclusa nell'aletta superiore. Grafica personalizzabile.

Ref.	Misure	Mat.		
10060200500	380 x 200 x 1280 mm	Cartone Microcanale	24	24 u

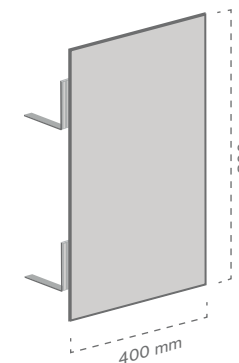

Pannello laterale per gondola, realizzato in polipropilene. Include 4 supporti a L per fissarlo ai ripiani. Grafica personalizzabile.

Ref.	Misure	Mat.		
10060200600	400 x 800 mm	PP Cellulare (3 mm)	28	28 u

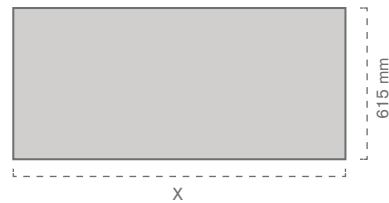
Bobina stampabile **calamitata**

Bobina calamitata da stampa. Personalizzabile in larghezza. Si adatta perfettamente a schiene di gondola e testata. 100% stampabile.

Ref.	Altezza bobina	Mat.		
10060200700	615 mm	Calamita	1	1 u



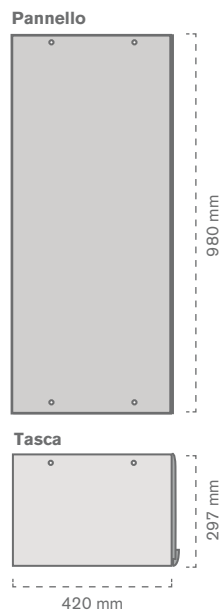

Kakemono

Kakemono con **tasca**

Kakemono bifacciale composto da un pannello in PVC espanso e una tasca formato A3 in PVC TTE unite da due ganci a C. Grafica e testi personalizzabili.

Ref.	Misure		Mat.	🛒	📄
	Pannello	Tasca			
10060300100	420 x 980 mm	420 x 297 mm	PVC Espanso (3 mm) e PVC	10	50 u
10060300500	420 x 980 mm	420 x 297 mm	PP Cellulare (3,5 mm) e PVC	10	50 u
10060300600	420 x 980 mm	420 x 297 mm	Cartone Microcanale (2,5 mm) e PVC	10	50 u

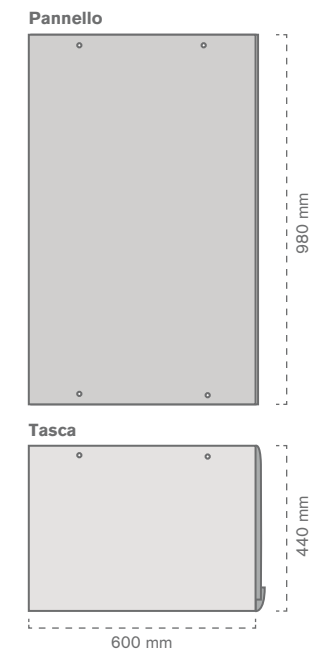
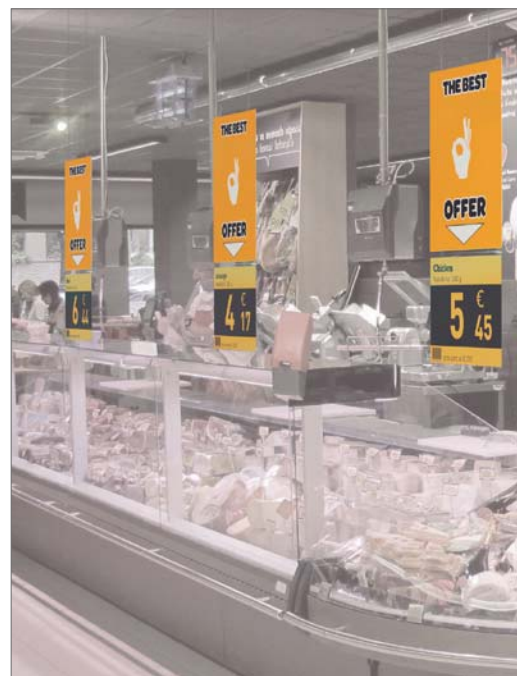
Kakemono con **tasca**

Kakemono bifacciale composto da un pannello in PVC espanso e una tasca da 600 x 440 mm. in PVC TTE unite da due ganci a C. Grafica e testi personalizzabili.

Ref.	Misure		Mat.	🛒	📄
	Pannello	Tasca			
10060300200	600 x 980 mm	600 x 440 mm	PVC Espanso (3 mm) e PVC	10	50 u
10060300700	600 x 980 mm	600 x 440 mm	PP Cellulare (3,5 mm) e PVC	10	50 u
10060300800	600 x 980 mm	600 x 440 mm	Cartone Microcanale (2,5 mm) e PVC	10	50 u

Kakemono con **tasca**

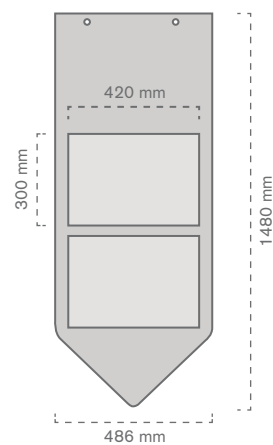

Kakemono bifacciale a forma di freccia. Include due tasche in PVC TTE formato A3.

Ref.	Misure		Mat.	🛍️	📄
	Pannello	Tasche			
10060300300	486 x 1480 mm	420 x 300 mm	PVC Espanso (2 mm) e PVC	10	50 u

Kakemono **base**

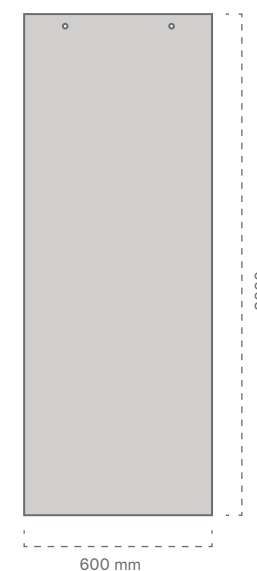

Kakemono bifacciale di PVC espanso senza tasca utilizzato principalmente per comunicazioni "private label".

Ref.	Misure	Mat.	🛍️	📄





FastUP



In tutti gli spazi commerciali, sia che si tratti di campagne, sia che si tratti di indicazioni merceologiche e informazioni di sicurezza, c'è sempre la necessità di comunicare. Solitamente queste informazioni vengono messe in alto, questo comporta la perdita di molto tempo e a volte è causa di "infortuni".

In GRUPO GP® abbiamo progettato un sistema per posizionare la cartellonistica. La principale funzione è quella di poterla posizionare direttamente da terra, grazie a una previa installazione, realizzata dalla nostra squadra di installatori che, una volta predisposto il punto vendita, si occuperà di formare il personale di quest'ultimo che si occupa della decorazione.

Caratteristiche del sistema

- 1 Installazione semplice e permanente del sistema di aggancio **FastUP**.
- 2 Sistema di pannelli in polipropilene come supporto per posizionare la cartellonistica.
- 3 La pertica, elemento che permette il cambio cartelli direttamente da terra.



Applicazioni

+
Info



Campagne lancio e stagionali o permanenti



Promozione di un marchio o di una famiglia di prodotti



Decorazione



Tipicità regionali

Componenti FastUP

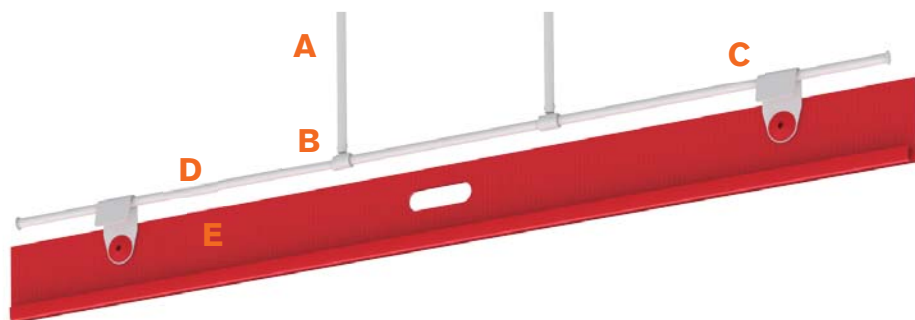

- A** Barre soffitto (possiamo posizionare prolunghe da 75 e 150 mm. fino a raggiungere una lunghezza di 600 mm.).
- B** Supporto per posizionare la barra di sospensione.
- C** Supporto per ancorare il pannello di polipropilene alla barra di sospensione.
- D** Barra metallica di sospensione.
- E** Pannello in polipropilene per posizionare la cartellonistica 980 mm. di larghezza.

Sistema FastUP per plafoniere



Aggancio per plafoniere

Questo modello utilizza un gancio speciale per plafoniere, che permette di impiantare cartellonistica con sistema FastUP anche in punti vendita con soffitto molto alto.

Sistema FastUP per controsoffitto



Sistema di aggancio per controsoffitto

Questo modello utilizza un gancio speciale che permette di impiantare cartellonistica con sistema FastUP anche in punti vendita con controsoffitto.

Sistema FastUP per soffitto in muratura



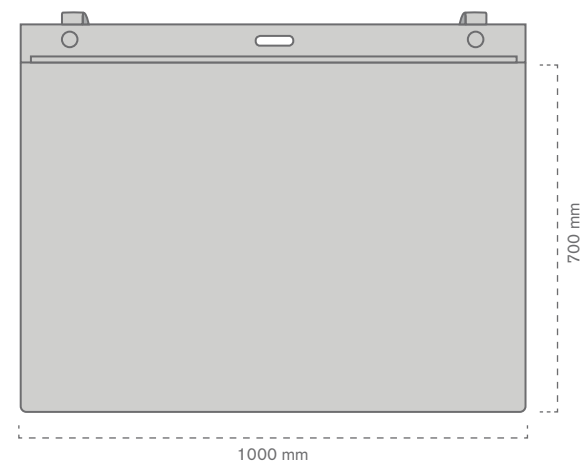

Sistema di aggancio per soffitto in muratura

Questo modello utilizza ganci speciali per muratura abbinati a ganci doppi che permettono di impiantare cartellonistica con sistema FastUP anche in punti vendita con soffitti di tipo comune.

346**FastUP**Modello **A**

Utilizzato principalmente per ambientazioni in zone di testata, supporta cartelli in formato 1000 x 700 mm. Questo modello include a scopo decorativo un pannello in polipropilene come cornice per cartelli.

Ref.	Misure	Mat.	Colore*		
10060400100	1000 x 700 mm	PP Cellulare (5 mm)	186 C	5	5 u

Modello B

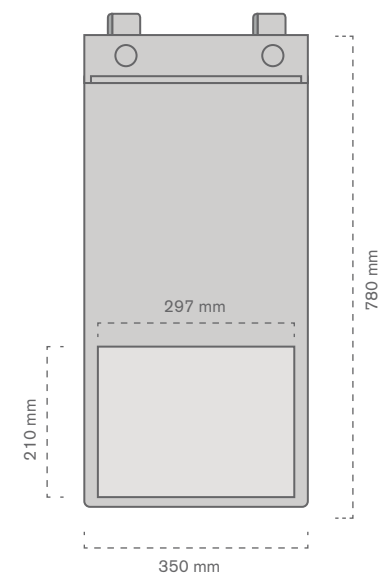

Pannello utilizzato principalmente nella zona freschi, panetteria e carne per comunicare offerte e promozioni. Include una tasca di personalizzazione formato A4 sul fondo.



Ref.	Misure		Mat.	Colore*	🛍️	📄
	Pannello	Tasca				
10060400200	350 x 780 mm	A4	PP Cellulare (5 mm) e PVC	186 C	5	5 u

*Referenza di colore Pantone.
A richiesta disponibile in altre colori.

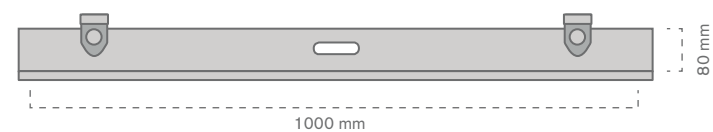
Modello C



Supporto per manifesti con una lunghezza massima di 1000 mm. Questo modello permette di comunicare su entrambi i lati ed è adatto per l'impiego in corridoi, zone di fresco e intestazioni.

Ref.	Misure	Mat.	Colore*		
10060400300	1000 x 80 mm	PP Cellulare (5 mm)	186 C	10	10 u

Accessori del sistema FastUP

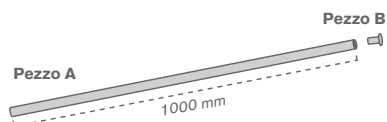

Ref.	Misure	Mat.	Colore		
10060400401	1000 mm	Metallo	BIANCO	10	10 u

Barra metallica e tappo.
Barra di fissaggio che si colloca al pannello base di polipropilene e tappo laterale.

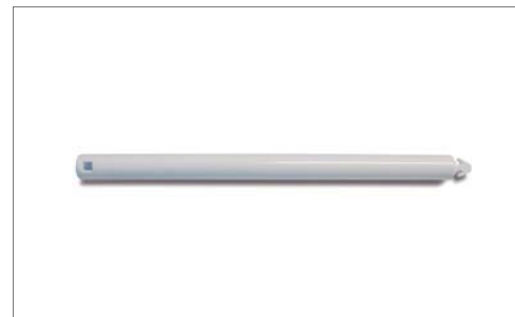

Ref.	Misure	Mat.	Colore		
10060400700	150 mm	PC	BIANCO	20	20 u
10060400800	75 mm	PC	BIANCO	20	20 u

Barra estensione.
Disponibile in due lunghezze, fa da prolunga al sistema di ancoraggio, fino a un massimo di 600 mm.

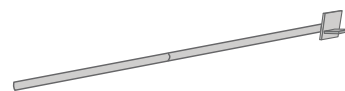

Ref.	Misure	Mat.	Colore		
10060400600	1800 mm	Metallo	BIANCO	1	1 u

Pertica.
Utilizzato per posizionare la cartellonistica direttamente da terra.

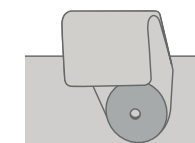

Ref.	Misure	Mat.	Colore		
10060400900	40 x 65 mm	PC	BIANCO	20	20 u

Ancora.
Serve per agganciare il supporto in polipropilene alla barra metallica.

350 FastUP

Accessori del sistema FastUP

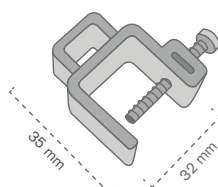

Ref.	Misure	Mat.	Colore		
10060401000	32 x 35 mm	PC	BIANCO	20	20 u

Gancio plafoniera.
Specifico per agganciare il sistema FastUP alle plafoniere.

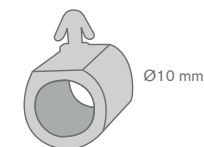

Ref.	Misure	Mat.	Colore		
10060401200	Ø10 mm	PC	BIANCO	20	20 u

Supporto barra estensione.
Funge da supporto per la barra estensione.

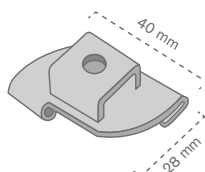

Ref.	Misure	Mat.	Colore		
10060401100	28 x 40 mm	PC	BIANCO	20	20 u

Gancio per controsoffitto.
Specifico per agganciare il sistema FastUP a controsoffittature.







Tasche formato **XL**

354 Tasche formato XL

Tasca doppia



Tasca inferiore formato A2 orizzontale, con tasca superiore (h 187 mm.) per messaggio promozionale.

Ref.	Misure		Mat.	🛒	📄
	Superiore	Inferiore			
10060500100	603 x 187 mm	603 x 418 mm	PETG TTE (750 my)	10	10 u
10060500200	603 x 187 mm	603 x 418 mm	AXPET MATE (750 my)	10	10 u

Tasca A2 orizzontale





Tasca trasparente formato A2 orizzontale. Apertura laterale per inserire le stampe.

Ref.	Misure	Mat.	🛒	📄
10060500400	600 x 440 mm	AXPET MATE (750 my)	10	10 u

Tasca poster





Tasca gigante per comunicazioni formato poster.

Ref.	Misure	Mat.		
				
10060500500	700 x 1020 mm	PETG TTE (750 my)	10	10 u
10060500600	700 x 1020 mm	AXPET MATE (750 my)	10	10 u
10060500700	500 x 700 mm	PETG TTE (750 my)	10	10 u
10060500800	500 x 700 mm	AXPET MATE (750 my)	10	10 u

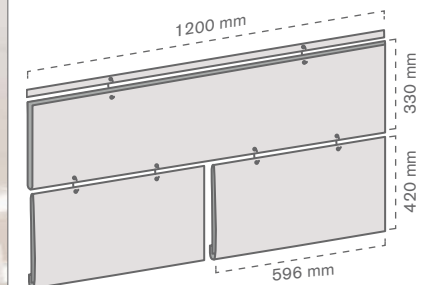
KIT tasche XL



Sistema composto da tre tasche trasparenti. Tasca superiore più due tasche inferiori. Il kit comprende profilo per sospensione e 6 ganci a C di raccordo.

Ref.	Misure		Mat.		
	Superiore	Inferiore			
10060500900	1200 x 330 mm	596 x 420 mm	PETG TTE (750 my)	10	10 u
10060501000	1200 x 330 mm	596 x 420 mm	AXPET MATE (750 my)	10	10 u





Indicatori di corsia

358 Indicatori di corsia

Pannello e tavolette



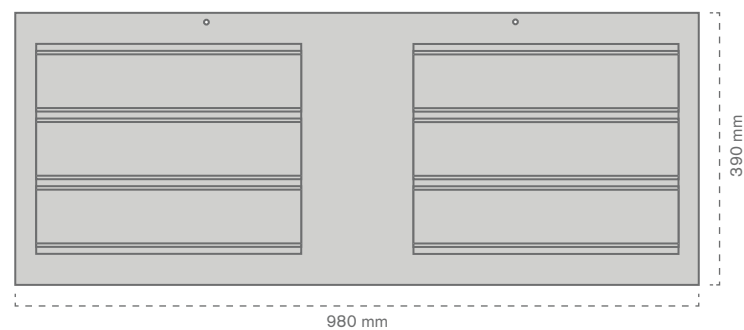

A. Pannello.

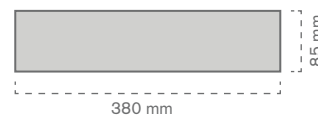

B. 12 tavolette merceologiche.



Indicatore di corsia in PVC espanso. L'articolo B è venduto in confezioni da 12 tavolette, separatamente dall'articolo A.

Pezzo	Ref.	Misure	Mat.	Colore		
A	10060600100	980 x 390 mm	PVC Espanso (3 mm)	NERO	1	9 u
B	10060600200	380 x 85 mm	PVC	NERO	1	1 u

Pannello e tavolette calamitate



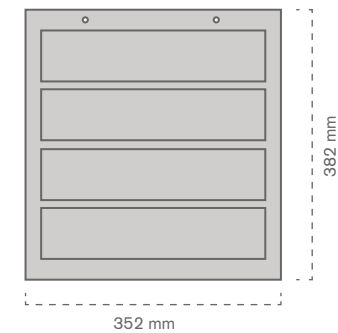

A. Pannello.

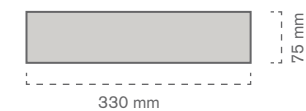

B. 4 tavolette calamitate.



Kit composto da due articoli: (A) pannello metallico e (B) 4 tavolette calamitate personalizzabili. Articoli venduti separatamente.

Pezzo	Ref.	Misure	Mat.	Colore		
A	10060600300	352 x 382 mm	Metallo	NERO	1	10 u
B	10060600400	330 x 75 mm	Calamita	NERO	1	1 u





Piccoli accessori

362 Piccoli accessori

Gancio adesivo **18 mm**

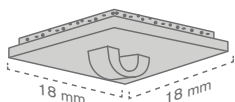

Ref.	Misure	Colore		
10050201400	18 x 18 mm	BIANCO	100	100 u

Gancio per **profilo controsoffitto**

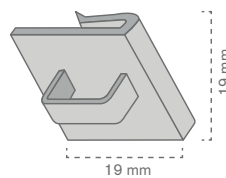

Ref.	Misure	Mat.		
10050201500	19 x 19 mm	PP Semitrasparente	100	100 u

Gancio metallico per **controsoffitto**



Ref.	Misure	Colore		
10050201600	28 x 40 mm	METALLO	50	50 u
10050201700	28 x 40 mm	BIANCO	50	50 u

Gancio doppio

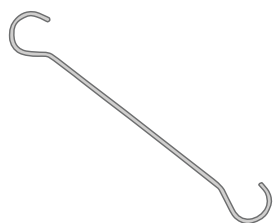

Ref.	Misure	Mat.	Icone	
10050200100	1000 mm	Metallo	50	50 u
10050200200	700 mm	Metallo	50	50 u
10050200300	500 mm	Metallo	50	50 u
10050200400	300 mm	Metallo	50	50 u
10050200500	150 mm	Metallo	50	50 u

Gancio a esse 40 e 25 mm



Ref.	Misure		Mat.	Icone	
	Lunghezza	Ø Materiale			
10050200600	40 mm	4 mm	Metallo	100	100 u
10050200700	25 mm	3 mm	Metallo	100	100 u

Gancio a esse 68 mm

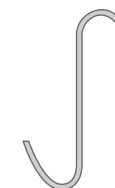
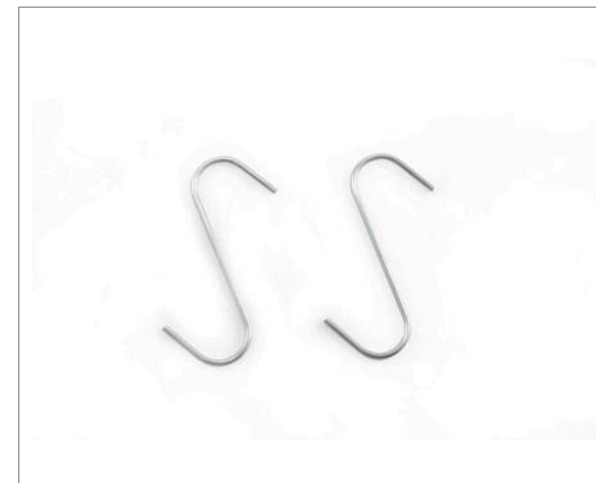

Ref.	Misure		Mat.	Icone	
	Lunghezza	Ø Materiale			
10050200800	68 mm	2 mm	Metallo	100	100 u

364 Piccoli accessori

Gancio a C

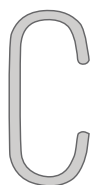

Ref.	Misure		Mat.	🛒	📄
	Lunghezza	Ø Materiale			
10050200900	39 mm	2 mm	Metallo	100	100 u

Cavo acciaio 2 mm e morsetti



Pezzo A

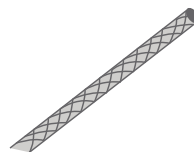

Pezzo B

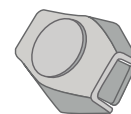

Pezzo	Ref.	Misure	Mat.	🛒	📄
B	10050203600	Per Ø2 mm	Metallo	100	100 u

Moschettone metallico

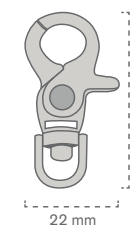

Ref.	Misure	Mat.	🛒	📄

Griptide



Ref.	Misure	Resistenza	Mat.		
10050203800	5 m	45 kg	Metallo	10	10 u
10050203900	3 m	45 kg	Metallo	10	10 u





Profili per cartellonistica

368 Profili per cartellonistica

Profilo **GP**

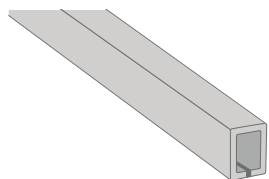

Ref.	Misure	Colore		
10060800100	1320 mm	BIANCO	50	50 u
10060800200	980 mm	BIANCO	50	50 u

Pinza per profilo GP



Ref.	Misure	Mat.		
10060800300	14 x 23 mm	Metallo	100	100 u

Profilo trasparente a **U**

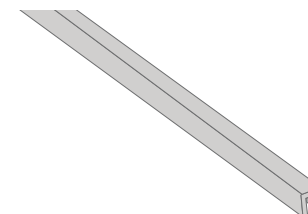
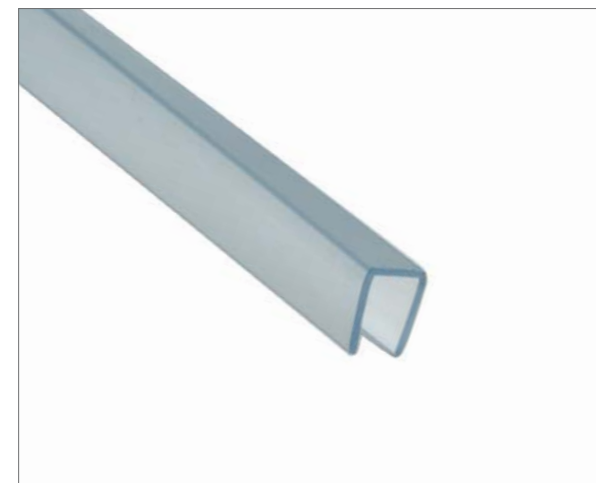

Ref.	Misure	Colore		
10060800400	1320 mm	TTE	10	10 u

Profilo porta cartelli **adesivo cellulosa**

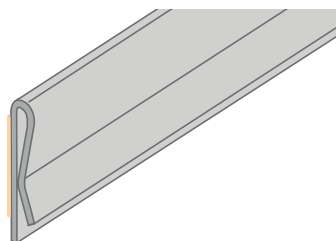

Ref.	Misure	Colore		
10060800600	1000 x 12 mm	TTE	100	100 u

Profilo **alluminio bianco**

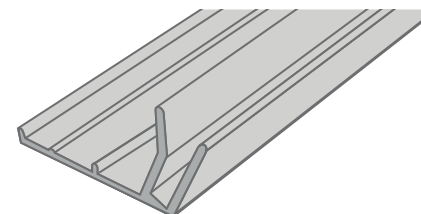

Ref.	Misure	Mat.		
10060800700	1325 mm	Alluminio BCO	10	10 u

370 Profili per cartellonistica

Profilo circolare e accessori

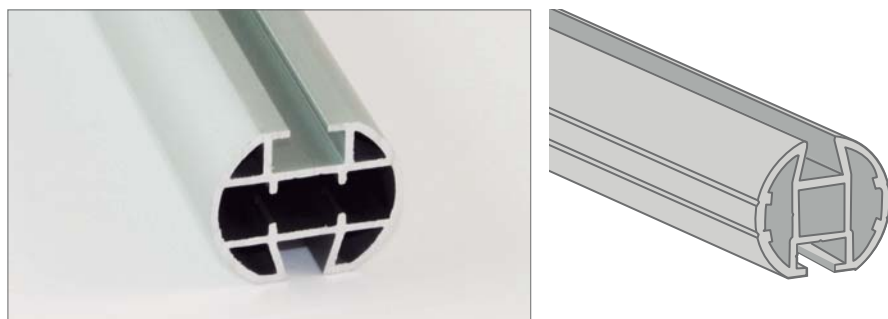

Referenza	Misure		Mat.		
	Ø	Lunghezza			
10060800800	30 mm	3 m	Metallo	54	54 u

Profilo circolare.
 Profilo studiato per la sospensione di cartellonistica aerea. Da utilizzare con i suoi accessori.



Ref.	Misure		Mat.		
	Ø	Lunghezza			
10060801000	6 mm	3 m	Metallo	54	54 u

Barra zincata.
 Si utilizza per sospendere cartellonistica telata, introducendolo nella guida inferiore del profilo circolare.



Ref.	Misure	Mat.		

Tappo in plastica.
 Tappo utilizzato per nascondere la sezione laterale del profilo.





Ref.	Misure	Mat.		

Vite con occhiello.
 Si utilizza per sospendere il profilo per mezzo di cavi d'acciaio.

Accessori per profilo circolare



Ref.	Misure	Mat.		
10060801200	M5 x 35 mm	Metallo	100	100 u

Vite per giunta.
Vite per fissare le giunture per profilo circolare.

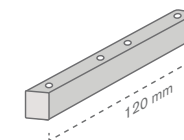

Ref.	Misure	Mat.		
10060801400	120 x 9 x 9 mm	Metallo	50	50 u

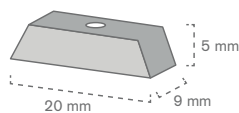

Giunta per profilo circolare.
Consente di unire più profili circolari.

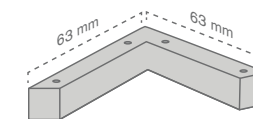

Ref.	Misure	Mat.		
10060801300	20 x 9 x 5 mm	Metallo	100	100 u

Trapezio.
Assieme alla vite M4 con occhio viene utilizzato per sospendere i profili circolari. Si introduce nella guida superiore del profilo.



Ref.	Misure	Mat.		
10060801600	63 x 63 mm	Metallo	25	25 u

Giunta ad angolo retto.
Consente di unire più profili circolari, formando angoli retti.

Fresh Market

by GRUPO GP

50% OFF
on 2nd

50% OFF
50% OFF
50% OFF
50% OFF

welcome to the way of savings

welcome to Fresh Market

As you VIP?

WELCOME

WELCOME

& vegeta

1,25€

1,25€

1,69€

Comunicazione da terra, vetrate e pareti

*Comunicazione da terra
OnCrystal
Teli e tessuti
Scritte 3D
Decorazione a pareti*





Comunicazione da terra

376 Comunicazione da terra

Adesivo antiscivolo

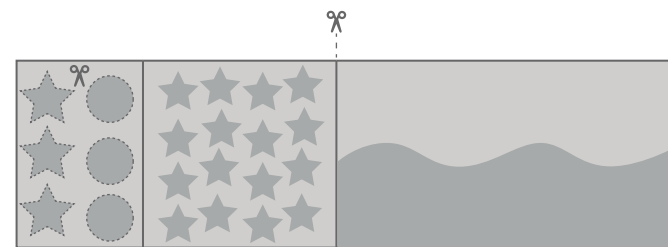

Forma e dimensioni del taglio personalizzabili.

Adesivo particolarmente adatto per la comunicazione e segnalazione nel suolo. La sua finitura antiscivolo rende il prodotto durevole e forte. Dimensione e forme personalizzabili.

Mod.	Referenza	Misure	Mat.	Spessore
1	10070100100	Personalizzabile	Vinile laminato	200 my
2	10070100200	Personalizzabile	Vinile laminato	125 my



Nota legale: La presenza di brands terzi in questo catalogo, hanno valore puramente illustrativo e non hanno pertanto funzioni promozionali.

378 Comunicazione da terra

Flexidecor® Print

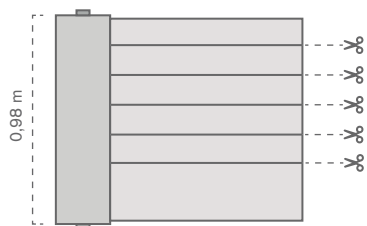

Parti di bobina personalizzabili in disegno e taglio (minimo 140 mm. altezza).



Flexidecor® Print è il modello più versatile ed ecologico della famiglia. Completamente personalizzabile, è possibile tagliare la bobina in quante parti vuoi.

Ref.	Misure	Mat.		
10040400100	47 x 0,98 m	Telo laminato	1 bobina	1 bobina
10040400200	24 x 0,98 m	Telo laminato	1 bobina	1 bobina
10040400300	12 x 0,98 m	Telo laminato	1 bobina	1 bobina



Nota legale: La presenza di brands terzi in questo catalogo, hanno valore puramente illustrativo e non hanno pertanto funzioni promozionali.

380 Comunicazione da terra

Copri pallet **metallico**

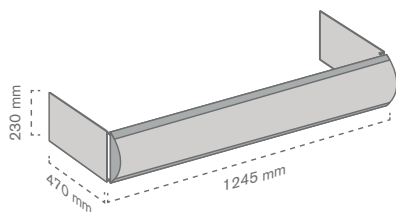

Ref.	Misure	Mat.	Colore		
10011300100	1245 x 470 x 230 mm	Metallo	NERO	1	10 u

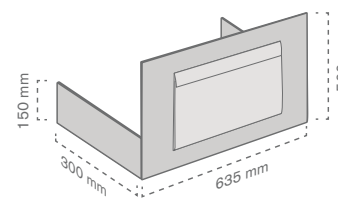

Stampa non inclusa.

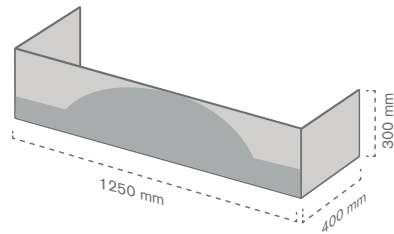

Ref.	Misure		Mat.	Colore		
	Generale	Tasca				
10011300200	635 x 300 x 500 mm	A3	Metallo	RAL 3020	1	10 u

Copri pallet in **polipropilene**



Ref.	Misure	Mat.	Colore		
10011300500	1250 x 400 x 300 mm	PP Cellulare (3,5 mm)	BIANCO	6	6 u

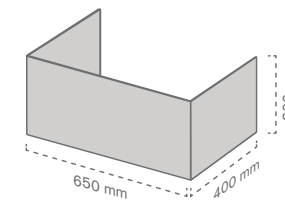



Ref.	Misure	Mat.	Colore		
10011300900	650 x 400 x 300 mm	PP Cellulare (3,5 mm)	BIANCO	12	12 u

382 Comunicazione da terra

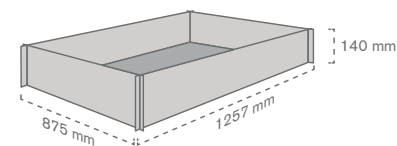
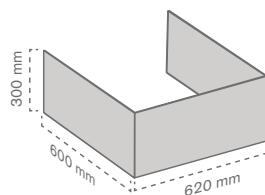
Copri pallet in **polipropilene**



Ref.	Misure	Mat.	Colore		
10011301300	620 x 600 x 300 mm	PP Cellulare (3,5 mm)	BIANCO	9	9 u

Ref.	Misure	Mat.	Colore		
10011300300	1257 x 875 x 140 mm	PP Cellulare (3,5 mm)	BIANCO	8	8 u





OnCrystal



SPECIAL OFFER!

HAIR MIST conditioning 500 ml 1 item **6,16[€]**

on 2nd item **3,08[€]**

shower gel silk glow purity 1 item **2,50[€]**

on 2nd item **1,25[€]**

- In risposta all'esigenza di comunicare su qualsiasi superficie del punto vendita, nasce **OnCrystal**, gamma di prodotti specifici per la comunicazione su vetri. Questa famiglia di prodotti permette di esporre e cambiare messaggi o informazioni su qualsiasi tipo di vetrata, comunicando verso l'interno e l'esterno del punto vendita.

I prodotti OnCrystal si distinguono per essere facili da usare e per non lasciare residui o macchie sulle vetrate. È possibile personalizzarli, adattandoli all'immagine coordinata del punto vendita.



Applicazioni



Campagne lancio e stagionali o permanenti



Promozione di un marchio o di una famiglia di prodotti



Informazioni

EasyPoster® 1 tasca



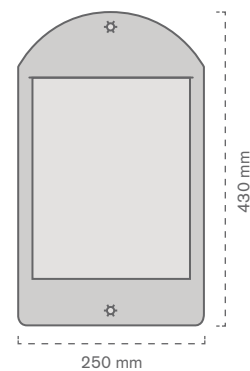

Modello A

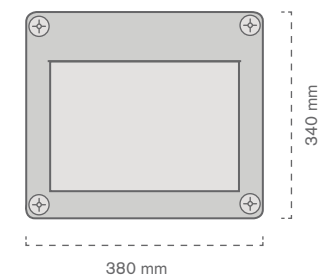

Modello B



EasyPoster® a una tasca formato A4. I modelli EasyPoster® sono progettati per aderire a superfici lisce. Forma, dimensioni e grafica personalizzabili.

Mod.	Ref.	Misure		Mat.		
		Generale	Display			
A	10070200200	250 x 430 mm	A4	PVC	4	4 u
B	10070200100	380 x 340 mm	A4	PVC	4	4 u

EasyPoster® 2 tasche



Modello A

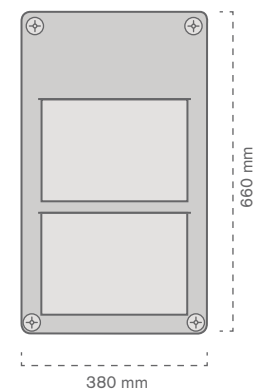

Modello B

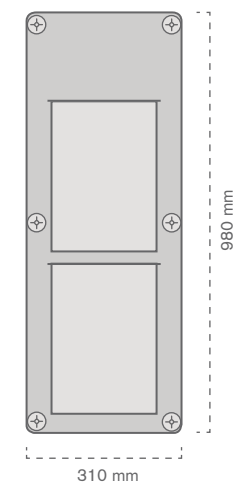

EasyPoster® a due tasche formato A4. I modelli EasyPoster® sono progettati per aderire a superfici lisce. Forma, dimensioni e grafica personalizzabili.

Mod.	Ref.	Misure		Mat.	📁	📄
		Generale	Display			
A	10070200300	380 x 660 mm	A4	PVC	2	2 u
B	10070200500	310 x 980 mm	A4	PVC	2	2 u

390 OnCrystal

EasyPoster® 3 tasche

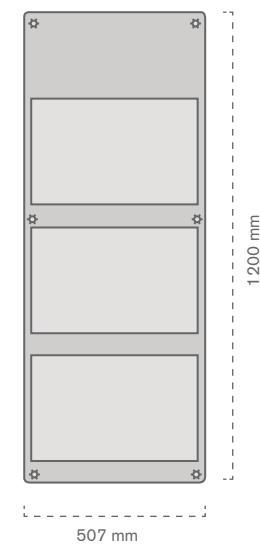



EasyPoster® a tre tasche formato A3. I modelli EasyPoster® sono progettati per aderire a superfici lisce. Forma, dimensioni e grafica personalizzabili.

Ref.	Misure		Mat.	🛒	📄
	Generale	Display			
10070200600	507 x 1200 mm	A3	PVC	2	2 u

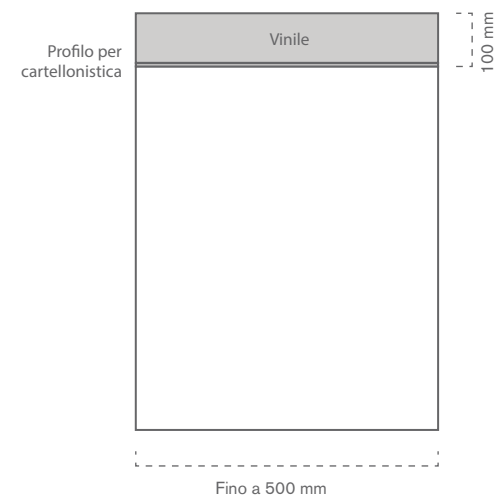
EasySlide



EasySlide consente di comunicare verso l'esterno del punto vendita. Consente un cambio di comunicazione facile e veloce. Completamente personalizzabile.

Ref.	Misure	Mat.		
10070200700	500 x 100 mm	Vinile e plastica	5	5 u

EasyFrame

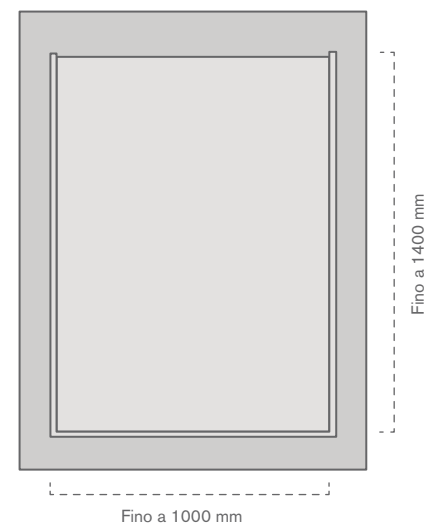



EasyFrame consente di comunicare contemporaneamente verso l'interno e l'esterno del punto vendita. Supporta comunicazioni di grande formato, fino a 1000 x 1400 mm. Si adatta facilmente a vetrate e porte scorrevoli.

Ref.	Misure	Mat.		
10070200800	1000 x 1400 mm	PVC, vinile e plastica	5	5 u

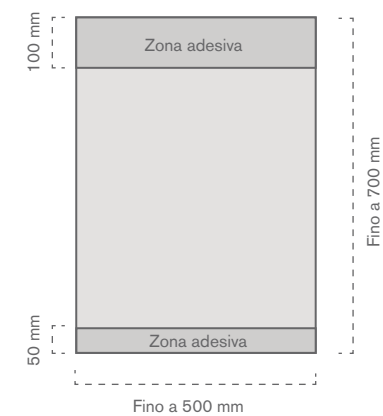
EasyStick



EasyStick è una tasca adesiva che consente di comunicare contemporaneamente verso l'interno e l'esterno del punto vendita. Disponibile in qualsiasi formato, fino a 500 x 700 mm.

Ref.	Misure	Mat.		
10070200900	500 x 700 mm	PVC e vinile	5	5 u





Teli e tessuti



- Teli e tessuti sono articoli molto versatili, che possono essere utilizzati per la decorazione, ambientazione e comunicazione per interni ed esterni. L'ampia gamma di materiali di cui si compone questa famiglia, ne fa uno strumento decorativo molto utile, che permette di realizzare composizioni personalizzate e di forte impatto in modo professionale e duraturo.

Di seguito proponiamo una raccolta di varie realizzazioni, applicazioni e materiali per la decorazione del punto vendita.

Tessuto microforato



PVC bianco



Applicazioni



Campagne lancio
e stagionali
o permanenti



Decorazione



Promozione
di un marchio
o di una famiglia
di prodotti



Distaccamento
di categoria



Tipicità regionali





Nota legale: La presenza di brands terzi in questo catalogo, hanno valore puramente illustrativo e non hanno pertanto funzioni promozionali.





Scritte 3D



Legno

- Le scritte tridimensionali sono una forma di comunicazione e segnalazione per eccellenza. All'interno del punto vendita vengono utilizzate principalmente per distinguere e valorizzare i diversi reparti, oltre ad essere utilizzate per la riproduzione di marchi ed elementi corporativi per interni ed esterni.

L'aumento della concorrenza, così come l'aumento delle superfici e dei reparti che compongono il punto vendita, rendono sempre più necessaria la distinzione di ognuno di essi in maniera omogenea. Per questo, vi proponiamo di seguito una selezione di materiali e realizzazioni utili all'immagine del vostro punto vendita.



PVC Espanso



Metallo



Cartone a Nido d'Ape



Metacrilato (PMMA)

Applicazioni



Classificazione e
segmentazione
di prodotto



Decorazione



Distacco
di categoria











Decorazione a pareti

408 Decorazione a pareti

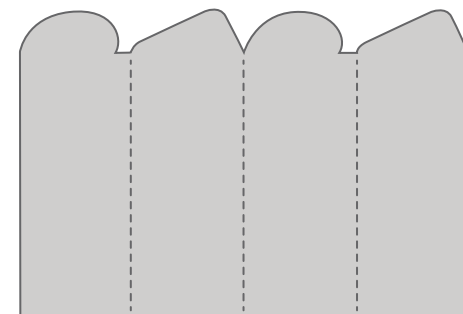
Copertura pilastri per colonne a forma **quadrata**



Copertura pilastri in polipropilene, particolarmente adatto per il rivestimento di colonne a forma quadrata. Si attacca con bottoni e velcro, ideale per decorare e comunicare nel punto vendita.

Ref.	Mat.		
10070500100	PP Cellulare (5 mm)	1	1 u
10070500300	Cartone Doppio Microcanale (4 mm)	1	1 u

Copertura pilastri per colonne a forma **circolare**

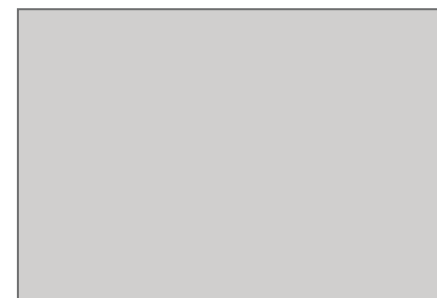

Rivestimenti tessili per colonne. Questo modello è dotato di un cinturino in velcro per una facile regolazione alla colonna. Come il modello precedente, è ideale per arredare e comunicare nel punto di vendita.

Ref.	Mat.		
10070500200	Telo	1	1 u

410 Decorazione a pareti







Pennarelli e ricariche

Pennarelli e ricariche

414 Pennarelli e ricariche

Pennarelli Illumigraph



Ref.	Punta	Colore		
10080100100	50 mm	BIANCO	6	6 u
10080100200	50 mm	GIALLO FL	6	6 u
10080100300	50 mm	ROSSO	6	6 u
10080100400	15 mm	BIANCO	12	12 u
10080100500	15 mm	GIALLO FL	12	12 u
10080100600	15 mm	ROSSO	12	12 u
10080100700	5 mm	BIANCO	12	12 u
10080100800	5 mm	GIALLO FL	12	12 u



Pennarelli con punte e inchiostri assortiti. Famiglia Illumigraph, cancellabile con acqua.

Pennarelli Posterman



Ref.	Punta	Colore		
10080100900	15 mm	BIANCO	6	6 u
10080101000	15 mm	GIALLO	6	6 u
10080101100	15 mm	ROSSO	6	6 u
10080101200	1 mm	BIANCO	12	12 u





Pennarelli con punte e inchiostri assortiti. Famiglia Posterman, resistenti all'acqua.



416 Pennarelli e ricariche

Ricarica





Ref.	Punte			Vasetto inchiostro a base solvente.
10080101300	6 mm/ 20 mm/ 35 mm/ 50 mm	1	1 u	Contenitore per inchiostro a base solvente. Include pennarelli con vari tipi di punta.



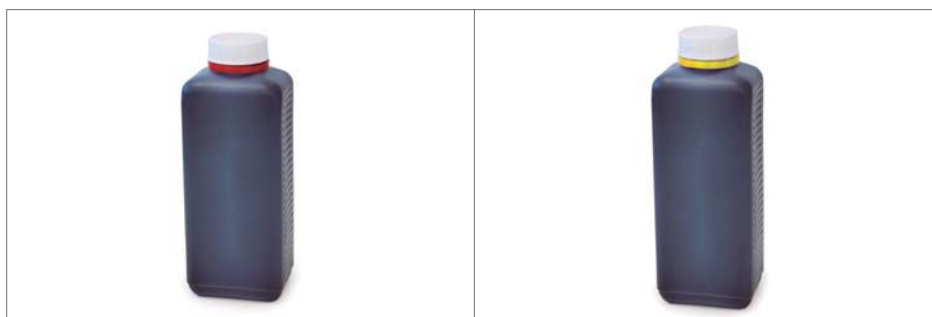

Ref.	Punte			Vasetto inchiostro a base acqua.
10080101600	6 mm/ 20 mm/ 35 mm/ 55 mm	1	1 u	Contenitore per inchiostro a base acqua. Include pennarelli con vari tipi di punta.



Ref.	Colore			Ricarica base solvente.
10080101400	ROSSO	1	1 u	Ricarica in bottiglia da 1 litro con inchiostro a base solvente. Inchiostro opaco, odore neutro e seccatura rapida.
10080101500	GIALLO	1	1 u	



Ref.	Colore			Ricarica base acqua.
10080101700	ROSSO	1	1 u	Ricarica in bottiglia da 1 litro con inchiostro a base acqua. Resistente all'acqua, inodore, non macchia
10080101800	GIALLO	1	1 u	

Solvente



Ref.	Contenuto			
10080101900	1 Litro	1	1 u	Solvente. Flacone solvente da 1 litro. Ideale per la rimozione d'inchiostro.

NOTE



*with you
361°*

with you
361°



MILANO

Via unita d'Italia, 10.
20060 Liscate (Milano) Italia
Tel. (+39) 02 8687 6001
Fax (+39) 02 8687 6052
info-italia@grupo-gp.com

Dove siamo:

ALICANTE

BILBAO

PORTO

